

Dell™ PowerEdge™ Expandable RAID Controller 4/SC, 4/DC, and 4e/DC User's Guide

[Overview](#)

[RAID Controller Features](#)

[Hardware Installation](#)

[Configuring the RAID Controller](#)

[BIOS Configuration Utility and Dell Manager](#)

[Troubleshooting](#)

[Appendix A: Regulatory Notice](#)

[Glossary](#)

Information in this document is subject to change without notice.
© 2004 Dell Inc. All rights reserved.

Reproduction in any manner whatsoever without the written permission of Dell Inc. is strictly forbidden.

Trademarks used in this text: *Dell*, the *DELL* logo, *PowerEdge*, and *Dell OpenManage* are trademarks of Dell Inc. *Microsoft* and *Windows* are registered trademarks of Microsoft Corporation. *Intel* is a registered trademark of Intel Corporation. *Novell* and *NetWare* are registered trademarks of Novell Corporation. *Red Hat* is a registered trademark of Red Hat, Inc.

Other trademarks and trade names may be used in this document to refer to either the entities claiming the marks and names or their products. Dell Inc. disclaims any proprietary interest in trademarks and trade names other than its own.

Model PERC 4

Release: July 2004
Part Number: D8096 Rev.A00

[Back to Contents Page](#)

Overview

Dell™ PowerEdge™ Expandable RAID Controller 4/SC, 4/DC, and 4e/DC User's Guide

- [Overview of PERC 4/SC, 4/DC, and 4e/DC](#)
 - [Documentation](#)
-

Overview of PERC 4/SC, 4/DC, and 4e/DC

The PERC 4 RAID controller is a high-performance, intelligent peripheral component interconnect (PCI) and PCI-Express to Small Computer System Interface (SCSI) host adapter with RAID control capabilities. It provides reliable fault-tolerant disk subsystem management and is an ideal RAID solution for internal storage in Dell's™ PowerEdge™ enterprise systems. The RAID controller offers a cost-effective way to implement RAID in a server.

PERC 4 controllers are available with one or two SCSI channels using PCI or PCI-Express input/output (I/O) architecture:

- 1 PERC 4/SC (single channel) provides one SCSI channel and PCI architecture
- 1 PERC 4/DC (dual channel) provides two SCSI channels and PCI architecture
- 1 PERC 4e/DC (dual channel) provides two SCSI channels and PCI-Express architecture

PCI and PCI-Express are I/O architectures designed to increase data transfers without slowing down the central processing unit (CPU). PCI-Express goes beyond the PCI specification in that it is intended as a unifying I/O architecture for various systems: desktops, workstations, mobile, server, communications, and embedded devices.

Your RAID controller supports a low-voltage differential (LVD) SCSI bus. Using LVD, you can use cables up to 12 meters long. Throughput on each SCSI channel can be as high as 320 MB/sec.

Documentation

The technical documentation set includes

- 1 *Dell PowerEdge RAID Controller 4/SC, 4/DC, and 4e/DC User's Guide*, which contains information about installation of the RAID controller, general introductory information about RAID, RAID system planning, configuration information, and software utility programs.
 - 1 *CERC and PERC RAID Controllers Operating System Driver Installation Guide*, which contains the information you need to install the appropriate operating system software drivers.
-

[Back to Contents Page](#)

RAID Controller Features

Dell™ PowerEdge™ Expandable RAID Controller 4/SC, 4/DC, and 4e/DC User's Guide

- [Hardware Requirements](#)
- [RAID Controller Specifications](#)
- [Configuration Features](#)
- [Hardware Architecture Features](#)
- [Array Performance Features](#)
- [Fault Tolerance Features](#)
- [Operating System Software Drivers](#)
- [RAID Management Utilities](#)

Hardware Requirements

The RAID controller can be installed in a system with a motherboard that has 5-V or 3.3-V, 32- or 64-bit PCI or PCI-Express slots.

 **NOTE:** PERC 4/DC and 4e/DC support clustering, but PERC 4/SC does not.

RAID Controller Specifications

[Table 2-1](#) provides a summary of the specifications for the RAID controllers.

Table 2-1. RAID Controller Specifications

Parameters	PERC 4/SC Specifications	PERC 4/DC Specifications	PERC 4e/DC Specifications
Card size	Low-profile PCI adapter card size (6.875" X 4.2")	Half-length PCI adapter card size (6.875" X 4.2")	Half-length PCI adapter card size (6.875" X 4.2")
Processor	Intel® GC80302 (Zion Lite)	Intel GC80303 (Zion)	80332
Bus type	PCI 2.2	PCI 2.2	PCI Express 1.0a
PCI bus data transfer rate	2 - 4 GB/sec, depending on the system	2 - 4 GB/sec, depending on the system	2 - 4 GB/sec, depending on the system
Cache configuration	64 MB SDRAM	128 MB SDRAM	128 MB SDRAM
Firmware	Flash size is 1MB	Flash size is 1MB	Flash size is 1MB
Nonvolatile random access memory (RAM)	32 KB for storing RAID configuration	32 KB for storing RAID configuration	32 KB for storing RAID configuration
Operating voltage and tolerances	3.3V +/- 0.3V, 5V +/- 5%, +12V +/- 5%, -12V +/- 10%	3.3V +/- 0.3V, 5V +/- 5%, +12V +/- 5%, -12V +/- 10%	3.3V +/- 0.3V, 5V +/- 5%, +12V +/- 5%, -12V +/- 10%
SCSI controller	One SCSI LSI53C1020 controller for Ultra320 support	One SCSI LSI53C1030 controller for Ultra320 support	One SCSI LSI53C1030 controller for Ultra320 support
SCSI data transfer rate	Up to 320 MB/sec per channel	Up to 320 MB/sec per channel	Up to 320 MB/sec per channel
SCSI bus	LVD, Single-ended (SE)	LVD, Single-ended (SE)	LVD, Single-ended (SE)
SCSI termination	Active	Active	Active
Termination disable	Automatic through cable and device detection	Automatic through cable and device detection This is automatic capable, but jumpers by default do not allow auto termination on PERC 4/DC.	Automatic through cable and device detection
Devices per SCSI channel	Up to 15 Wide SCSI devices	Up to 15 Wide SCSI devices	Up to 15 Wide SCSI devices
SCSI device types	Synchronous or asynchronous	Synchronous or asynchronous	Synchronous or asynchronous
RAID levels supported	0, 1, 5, 10, 50	0, 1, 5, 10, 50	0, 1, 5, 10, 50
SCSI connectors	One 68-pin internal high-density connector for SCSI devices. One very high density 68-pin external connector for Ultra320 and	Two 68-pin internal high-density connectors for SCSI devices. Two very high density 68-pin external connectors for Ultra320 and	Two 68-pin internal high-density connectors for SCSI devices. Two very high density 68-pin external connectors for

	Wide SCSI.	Wide SCSI.	Ultra320 and Wide SCSI.
Serial port	3-pin RS232C-compatible connector (for manufacturing use only)	3-pin RS232C-compatible connector (for manufacturing use only)	3-pin RS232C-compatible connector (for manufacturing use only)

 **NOTE:** PERC 4 controller cards are not PCI Hot Pluggable. The system must be powered down in order to change or add cards.

Cache Memory

64 MB of cache memory resides in a memory bank for PERC 4/SC and 128 MB for PERC 4/DC and PERC 4e/DC. The RAID controller supports write-through or write-back caching, selectable for each logical drive. To improve performance in sequential disk accesses, the RAID controller uses read-ahead caching by default. You can disable read-ahead caching.

Onboard Speaker

The RAID controller has a speaker that generates audible warnings when system errors occur. No management software needs to be loaded for the speaker to work.

Alarm Beep Codes

The purpose of the alarm is to indicate changes that require attention. The following conditions trigger the alarm to sound:

- 1 A logical drive is offline
- 1 A logical drive is running in degraded mode
- 1 An automatic rebuild has been completed
- 1 The temperature is above or below the acceptable range
- 1 The firmware gets a command to test the speaker from an application

Each of the conditions has a different beep code, as shown in [Table 2-2](#). Every second the beep switches on or off per the pattern in the code. For example, if the logical drive goes offline, the beep code is a three second beep followed by one second of silence.

Table 2-2. Alarm Beep Codes

Alarm Description	Code
A logical drive is offline.	Three seconds on, one second off
A logical drive is running in degraded mode.	One second on, one second off
An automatic rebuild has been completed.	One second on, three seconds off
The temperature is above or below the acceptable range.	Two seconds on, two seconds off
The firmware gets a command to test the speaker from an application.	Four seconds on

BIOS

For easy upgrade, the BIOS resides on 1 MB flash memory. It provides an extensive setup utility that you can access by pressing <Ctrl><M> at BIOS initialization to run the BIOS Configuration Utility.

Background Initialization

Background initialization is the automatic check for media errors on physical drives. It ensures that striped data segments are the same on all physical drives in an array.

The background initialization rate is controlled by the rebuild rate set using the BIOS Configuration Utility, <Ctrl><M>. The default and recommended rate is 30%. Before you change the rebuild rate, you must stop the background initialization or the rate change will not affect the background initialization rate. After you stop background initialization and change the rebuild rate, the rate change takes effect when you restart background initialization.

 **NOTE:** Unlike initialization of logical drives, background initialization does not clear data from the drives.

Configuration Features

[Table 2-3](#) lists the configuration features for the RAID controller.

Table 2-3. Configuration Features

Specifications	PERC 4/SC	PERC 4/DC	PERC 4e/DC
RAID levels	0, 1, 5, 10, and 50	0, 1, 5, 10, and 50	0, 1, 5, 10, and 50
SCSI channels	1	2	2
Maximum number of drives per channel	14	14 (for a maximum of 28 on two channels)	14 (for a maximum of 28 on two channels)
Array interface to host	PCI Rev 2.2	PCI Rev 2.2	PCI Express Rev. 1.0a
Cache memory size	64 MB SDRAM	Up to 128 MB SDRAM	Up to 128 MB SDRAM
Cache Function	Write-back, write-through, adaptive read-ahead, non read-ahead, read-ahead	Write-back, write-through, adaptive read-ahead, non read-ahead, read-ahead	Write-back, write-through, adaptive read-ahead, non read-ahead, read-ahead
Number of logical drives and arrays supported	Up to 40 logical drives and 32 arrays per controller	Up to 40 logical drives and 32 arrays per controller	Up to 40 logical drives and 32 arrays per controller
Hot spares	Yes	Yes	Yes
Flashable firmware	Yes	Yes	Yes
Hot swap devices supported ¹	Yes	Yes	Yes
Non-disk devices supported	Only SCSI accessed fault-tolerant enclosure (SAF-TE) and SES	Only SAF-TE and SES	Only SAF-TE and SES
Mixed capacity hard drives	Yes	Yes	Yes
Number of 16-bit internal connectors	1	2	2
Cluster support	No	Yes	Yes

¹ Hot swap of drives must be supported by enclosure or backplane.

Firmware Upgrade

You can download the latest firmware from the Dell website and flash it to the firmware on the board. Perform the following steps to upgrade the firmware:

1. Go to the support.dell.com website.
2. Download the latest firmware and driver to a diskette.

The firmware is an executable file that downloads the files to the diskette in your system.

3. Restart the system and boot from the diskette.
4. Run `pflash` to flash the firmware.

 **NOTICE:** Do not flash the firmware while performing a background initialization or data consistency check, as it can cause the procedures to fail.

SMART Hard Drive Technology

The Self-Monitoring Analysis and Reporting Technology (SMART) detects predictable hard drive failures. SMART monitors the internal performance of all motors, heads, and hard drive electronics.

Drive Roaming

Drive roaming occurs when the hard drives are changed to different channels on the same controller. When the drives are placed on different channels, the controller detects the RAID configuration from the configuration information on the drives.

Configuration data is saved in both non-volatile random access memory (NVRAM) on the RAID controller and on the hard drives attached to the controller. This maintains the integrity of the data on each drive, even if the drives have changed their target ID. Drive roaming is supported across channels on the same controller, except when cluster mode is enabled.

 **NOTE:** Drive roaming does not work if you move the drives to a new controller and put them on different channels. If you put drives on a new controller, the controller must have a clear configuration. In addition, the drives must be on the same channel/target as they were on the previous controller to keep the same configuration.

 **NOTE:** Before performing drive roaming, make sure that you have first powered off both your platform and your drive enclosure.

[Table 2-4](#) lists the drive roaming features for the RAID controller.

Table 2-4. Features for Drive Roaming

Specification	PERC 4/SC	PERC 4/DC	PERC 4e/DC
Online RAID level migration	Yes	Yes	Yes
RAID remapping	Yes	Yes	Yes
No reboot necessary after capacity extension	Yes	Yes	Yes

Drive Migration

Drive migration is the transfer of a set of hard drives in an existing configuration from one controller to another. The drives must remain on the same channel and be reinstalled in the same order as in the original configuration.

 **NOTE:** Drive roaming and drive migration cannot be supported at the same time. PERC can support either drive roaming or drive migration at any one time, but not both at the same time.

Hardware Architecture Features

[Table 2-5](#) displays the hardware architecture features for the RAID controller.

Table 2-5. Hardware Architecture Features

Specification	PERC 4/SC	PERC 4/DC	PERC 4e/DC
Processor	Intel GC80302 (Zion Lite)	Intel GC80303 (Zion)	80332
SCSI controller(s)	One LSI53C1020 Single SCSI controller	One LSI53C1030 Dual SCSI controller	One LSI53C1030 Dual SCSI controller
Size of flash memory	1 MB	1 MB	1 MB
Amount of NVRAM	32 KB	32 KB	32 KB
Hardware exclusive OR (XOR) assistance	Yes	Yes	Yes
Direct I/O	Yes	Yes	Yes
SCSI bus termination	Active or LVD	Active or LVD	Active or LVD
Double-sided dual inline memory modules (DIMMs)	Yes	Yes	Yes
Support for hard drives with capacities of more than eight gigabytes (GB)	Yes	Yes	Yes
Hardware clustering support on the controller	No	Yes	Yes

LED Operation

After you remove a physical drive and place it back in the slot for a rebuild, the LED blinks for the drive as it is being rebuilt.

Array Performance Features

[Table 2-6](#) displays the array performance features for the RAID controller.

Table 2-6. Array Performance Features

Specification	PERC 4/SC, PERC 4/DC, and PERC 4e/DC
PCI host data transfer rate	2 - 4 GB/sec, depending on the system
Drive data transfer rate	Up to 320 MB/sec
Maximum size of I/O requests	6.4 MB in 64 KB stripes
Maximum queue tags per drive	As many as the drive can accept
Stripe sizes	8 KB, 16 KB, 32 KB, 64 KB, or 128 KB
Maximum number of concurrent commands	255
Support for multiple initiators	Only on PERC 4/DC and PERC 4e/DC

Fault Tolerance Features

[Table 2-7](#) describes the fault tolerance capabilities of the RAID controller.

Table 2-7. Fault Tolerance Features

Specification	PERC 4/SC	PERC 4/DC	PERC 4e/DC
Support for SMART	Yes	Yes	Yes
Optional battery backup for cache memory	N/A	Yes. Up to 72 hours data retention. ¹	Yes. Up to 72 hours data retention.
Drive failure detection	Automatic	Automatic	Automatic
Drive rebuild using hot spares	Automatic	Automatic	Automatic
Parity generation and checking	Yes	Yes	Yes
User-specified rebuild rate	Yes	Yes	Yes

¹ The length of data retention depends on the cache memory configuration.

Operating System Software Drivers

Operating System Drivers

Drivers are provided to support the controller on the following operating systems:

- 1 Windows® 2000
- 1 Windows 2003
- 1 Novell® NetWare®
- 1 Red Hat® Linux, Advanced Server, Enterprise

 **NOTE:** We support both 32-bit (x86) and 64-bit (IA64) processors for Windows 2003 and Red Hat Linux.

See the *CERC and PERC RAID Controllers Operating System Driver Installation Guide* for more information about the drivers.

SCSI Firmware

The RAID controller firmware handles all RAID and SCSI command processing and supports the features described in [Table 2-8](#).

Table 2-8. SCSI Firmware Support

Feature	PERC 4/SC, PERC 4/DC, and PERC 4e/DC Description
Disconnect/reconnect	Optimizes SCSI bus utilization
Tagged command queuing	Multiple tags to improve random access
Multi-threading	Up to 255 simultaneous commands with elevator sorting and concatenation of requests per SCSI channel
Stripe size	Variable for all logical drives: 8 KB, 16 KB, 32 KB, 64 KB, or 128 KB.
Rebuild	Multiple rebuilds and consistency checks with user-definable priority.

RAID Management Utilities

Software utilities enable you to manage and configure the RAID system, create and manage multiple disk arrays, control and monitor multiple RAID servers, provide error statistics logging, and provide online maintenance. The utilities include:

- 1 BIOS Configuration Utility
- 1 Dell Manager for Linux
- 1 Dell OpenManage™ Array Manager for Windows and Netware

BIOS Configuration Utility

The BIOS Configuration Utility configures and maintains RAID arrays, clears hard drives, and manages the RAID system. It is independent of any operating system. See [BIOS Configuration Utility and Dell Manager](#) for additional information.

Dell Manager

Dell Manager is a utility that works in Red Hat Linux. See [BIOS Configuration Utility and Dell Manager](#) for additional information.

Dell OpenManage Array Manager

Dell OpenManage Array Manager is used to configure and manage a storage system that is connected to a server, while the server is active and continues to handle requests. Array Manager runs under Novell NetWare, Windows 2000, and Windows Server 2003. Refer to the online documentation that accompanies Array Manager or the documentation section at [support.dell.com](#) for more information.

 **NOTE:** You can run the OpenManage Array Manager remotely to access NetWare, but not locally.

Server Administrator Storage Management Service

Storage Management provides enhanced features for configuring a system's locally attached RAID and non-RAID disk storage. Storage Management runs under Red Hat Linux, Windows 2000, and Windows Server 2003. Refer to the online documentation that accompanies Storage Management or the documentation section at [support.dell.com](#) for more information.

[Back to Contents Page](#)

Hardware Installation

Dell™ PowerEdge™ Expandable RAID Controller 4/SC, 4/DC, and 4e/DC User's Guide

- [Requirements](#)
 - [Quick Installation Procedure](#)
 - [Installation Steps](#)
-

Requirements

This section describes the procedures for installing the RAID controller. You must have the following items to install the controller:

- 1 A PERC 4/SC, 4/DC, or 4e/DC controller
 - 1 A host system with an available 32- or 64-bit, PCI extension slot for PERC 4/SC or 4/DC, and a PCI-Express slot for PERC 4e/DC
 - 1 The *Dell OpenManage™ Systems Management* CD or driver diskette
 - 1 The necessary internal and/or external SCSI cables
 - 1 Ultra, Ultra2, Ultra3, Ultra160, or Ultra320 SCSI hard drives (SCSI is backward compatible, but it slows to the speed of the slowest device).
-

Quick Installation Procedure

Perform the following steps for quick installation of the controller if you are an *experienced system user/installer*. All others should follow the steps in the next section, [Installation Steps](#).

 **CAUTION:** See your *Product Information Guide* for complete information about safety precautions, working inside the computer, and protecting against electrostatic discharge.

1. Turn off all power to the server and all hard drives, enclosures, and system components, then disconnect power cords from the system.
2. Open host system by following the instructions in the host system technical documentation.
3. Determine the SCSI ID and SCSI termination requirements.

 **NOTE:** The default for SCSI termination is onboard SCSI termination enabled. See the section [Step 7 Set SCSI Termination](#) for a description of SCSI termination.

4. Install the PERC 4/SC or 4/DC RAID controller in a PCI slot or the PERC 4e/DC in the PCI- Express slot in the server and attach the SCSI cables and terminators.

See the section [Cable Suggestions](#) for cable information and suggestions.

1. Make sure pin 1 on the cable matches pin 1 on the connector.
 1. Make sure that the SCSI cables conform to all SCSI specifications.
 5. Perform a safety check.
 1. Make sure all cables are properly attached.
 1. Make sure the RAID controller is properly installed.
 1. Close the cabinet of the host system.
 1. Turn power on after completing the safety check.
 6. Format the hard drives as needed.
 7. Configure logical drives using the BIOS Configuration Utility or Dell Manager.
 8. Initialize the logical drives.
 9. Install the network operating system drivers as needed.
-

Installation Steps

This section provides instructions for installing the RAID controllers.

Step 1 Unpack the Controller

⚠ CAUTION: See your *Product Information Guide* for complete information about safety precautions, working inside the computer, and protecting against electrostatic discharge.

Unpack and remove the controller and inspect it for damage. If the controller appears damaged, or if any items listed below are missing, contact your Dell support representative. The RAID controller is shipped with:

- 1 The *PERC 4 RAID Controller User's Guide* (on CD)
- 1 The *CERC and PERC RAID Controllers Operating System Driver Installation Guide* (on CD)

📄 NOTE: You can order a hard copy of the documentation for the controller.

- 1 A license agreement

Step 2 Power Down the System

⚠ CAUTION: See your *Product Information Guide* for complete information about safety precautions, working inside the computer, and protecting against electrostatic discharge.

Perform the following steps to power down the system:

1. Turn off the system.
2. Remove the AC power cord.
3. Disconnect the system from any networks before installing the controller.
4. Remove the system's cover.

Please consult the system documentation for instructions.

Step 3 Set Jumpers

Make sure the jumper settings on the RAID controller are correct. The default jumper settings are recommended. Following are diagrams of the controllers showing their jumpers and connectors, and tables describing them. Select your controller from the ones shown on the following pages.

Figure 3-1. PERC 4/SC Controller Layout

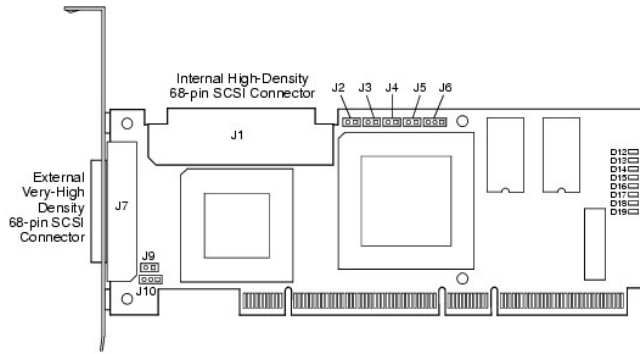

Table 3-1. PERC 4/SC Jumper and Connector Descriptions

Connector	Description	Type	Setting
J1	Internal SCSI connector	68-pin connector	Internal high-density SCSI bus connector. Connection is optional.
J2	NVRAM Clear	2-pin header	To CLEAR configuration data, install a jumper.
J3	Serial EPROM	2-pin header	To CLEAR configuration data, install a jumper.
J4	Onboard BIOS Enable	2-pin header	No jumper = Enabled (Default is Enabled) With jumper in = Disabled
J5	SCSI Activity	2-pin header	Connector for enclosure LED to indicate data transfers. Connection is optional.
J6	Serial Port	3-pin header	Connector is for diagnostic purposes. Pin-1 RXD (Receive Data) Pin-2 TXD (Transmit Data) Pin-3 GND (Ground)
J7	External SCSI connector	68-pin connector	External very-high density SCSI bus connector. Connection is optional.
J9	SCSI bus TERMPWR Enable	2-pin header	Install jumper to enable onboard termination power. Default is installed.
J10	SCSI bus Termination Enable	3-pin header	Jumper pins 1-2 to enable software control of SCSI termination through drive detection. Jumper pins 2-3 to disable onboard SCSI termination. No jumper installed enables onboard SCSI termination. This is the default.
D12 - D19	LEDs		Indicate problems with the card.

Figure 3-2. PERC 4/DC Controller Layout

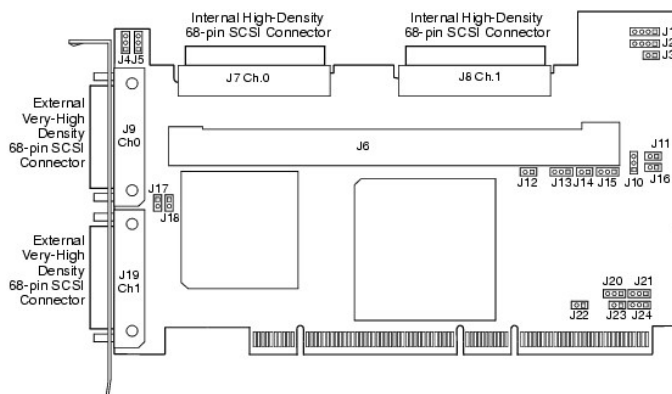

Table 3-2. PERC 4/DC Jumper and Connector Descriptions

Connector	Description	Type	Settings
J1	I2C Header	4-pin header	Reserved.
J2	SCSI Activity LED	4-pin header	Connector for LED on enclosure to indicate data transfers. Optional.
J3	Write Pending Indicator	2-pin header	Connector for enclosure LED to indicate when data in the cache has yet to be written to the

	(Dirty Cache LED)		device. Optional.
J4	SCSI Termination Enable Channel 1	3-pin header	Jumper pins 1-2 to enable software control of SCSI termination via drive detection.
J5	SCSI Termination Enable Channel 0	3-pin header	Jumper pins 2-3 to disable onboard SCSI termination. No jumper installed enables onboard SCSI termination. (See J17 and J18). This is the default.
J6	DIMM socket	DIMM socket	Socket that hold the memory module
J7	Internal SCSI Channel 0 connector	68-pin connector	Internal high-density SCSI bus connector. Connection is optional.
J8	Internal SCSI Channel 1 connector	68-pin connector	Internal high-density SCSI bus connector. Connection is optional.
J9	External SCSI Channel 0 connector	68-pin connector	External very-high density SCSI bus connector. Connection is optional.
J10	Battery connector	3-pin header	Connector for an optional battery pack. Pin-1 -BATT Terminal (black wire) Pin-2 Thermistor (white wire) Pin-3 +BATT Terminal (red wire)
J11	NVRAM clear	2-pin header	To CLEAR the configuration data, install a jumper.
J12	NMI jumper	2-pin header	Reserved for factory.
J13	32-bit SPCI Enable	3-pin header	Reserved for factory.
J14	Mode Select jumper	2-pin header	
J15	Serial Port	3-pin header	Connector is for diagnostic purposes. Pin-1 RXD (Receive Data) Pin-2 TXD (Transmit Data) Pin-3 GND (Ground)
J16	Onboard BIOS Enable	2-pin header	No jumper = Enabled (Default setting) Jumpered = Disabled
J17	TERMPWR Enable Channel 0	2-pin header	Jumper installed enables TERMPWR from the PCI bus. Default setting.
J18	TERMPWR Enable Channel 1	2-pin header	No jumper installed enables TERMPWR from the SCSI bus. (See J4 and J5)
J19	External SCSI Channel 1 connector	68-pin connector	External very-high density SCSI bus connector. Connection is optional.
J23	Serial EEPROM	2-pin header	To CLEAR configuration data, install a jumper.
D17 - D24	LEDs (located on back of card)		Indicate problems with the card.

Figure 3-3. PERC 4e/DC Controller Layout

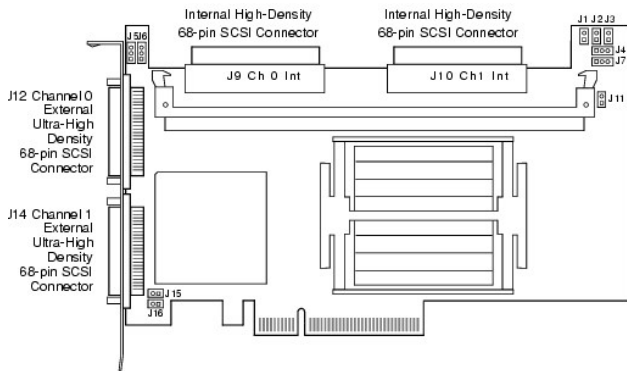

Table 3-3. PERC 4e/DC Jumper and Connector Descriptions

Connector	Description	Type	Settings
J1	Write Pending Indicator (Dirty Cache LED)	2-pin header	Connector for enclosure LED to indicate when data in the cache has yet to be written to the device. Optional.
J2	Onboard BIOS Enable	2-pin header	No jumper = Enabled (Default setting) Jumpered = Disabled
J4	I2C Header	3-pin header	Reserved
J5	SCSI Termination Enable Channel 0	3-pin header	Jumper pins 1-2 to enable software control of SCSI termination via drive detection.
J6	SCSI Termination Enable Channel 1	3-pin header	Jumper pins 2-3 to disable onboard SCSI termination. No jumper installed enables onboard SCSI termination. (See J17 and J18). This is the default.
J7	Serial Port (RS232)	3-pin header	Connector is for diagnostic purposes. Pin-1 RXD (Receive Data) Pin-2 TXD (Transmit Data) Pin-3 GND (Ground)

J9	Internal SCSI Channel 0 connector	68-pin connector	Internal high-density SCSI bus connector. Connection is optional.
J10	Internal SCSI Channel 1 connector	68-pin connector	Internal high-density SCSI bus connector. Connection is optional.
J11	Mode Select	2-pin header	Reserved for internal use.
J12	External SCSI Channel 0 connector	68-pin connector	External very-high density SCSI bus connector. Connection is optional.
J14	External SCSI Channel 1 connector	68-pin connector	External very-high density SCSI bus connector. Connection is optional.
J15	Termination Power	2-pin connector	
J16	Termination Power	2-pin connector	

Step 4 Install the RAID Controller

⚠ CAUTION: See your *Product Information Guide* for complete information about safety precautions, working inside the computer, and protecting against electrostatic discharge.

Perform the following steps to install the controller:

1. Select a PCI slot for PERC 4/SC or PERC 4/DC, or a PCI-Express slot for PERC 4e/DC and align the controller PCI bus connector to the slot.
2. Press down gently but firmly to make sure that the controller is properly seated in the slot, as shown in [Figure 3-4](#) and [Figure 3-5](#).
3. Screw the bracket to the system chassis.

⚠ CAUTION: You cannot install a PCI board in a PCI-Express slot or a PCI-Express board in a PCI slot.

Figure 3-4. Inserting a PERC 4 RAID Controller into a PCI Slot

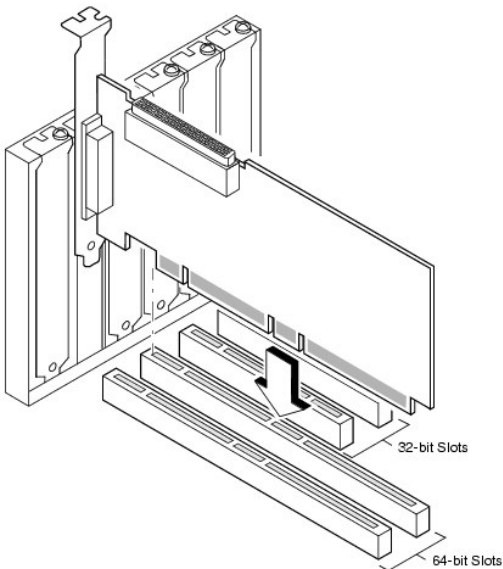
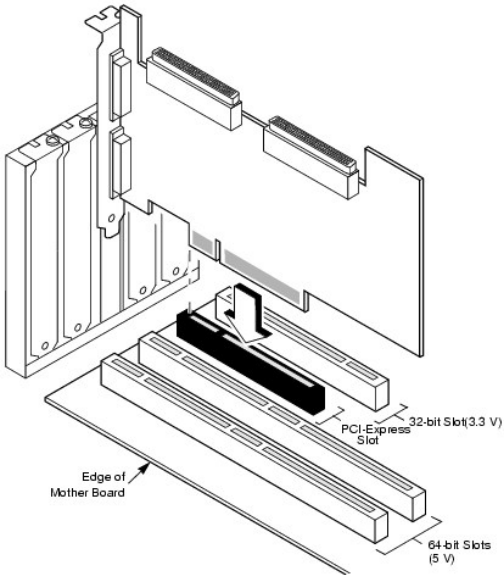

Figure 3-5. Inserting a PERC 4e/DC RAID Controller in a PCI-Express Slot



Step 5 Connect SCSI Cables and SCSI Devices

Connect the SCSI cables to the SCSI connectors and SCSI devices.

Connect SCSI Devices

Perform the following steps to connect SCSI devices.

1. Disable termination on any SCSI device that does *not* sit at the end of the SCSI bus.
2. Configure all SCSI devices to supply TermPWR.
3. Set proper target IDs (TIDs) for all SCSI devices.
4. The host controller has a SCSI ID of 7.
5. Connect the cable to the devices.

 **NOTE:** The maximum cable length for Fast SCSI (10 MB/sec) devices is 3 meters and for Ultra SCSI devices is 1.5 meters. The cable length can be up to 12 meters for LVD devices. Use shorter cables if possible.

Cable Suggestions

System throughput problems can occur if the SCSI cables are not the correct type. To avoid problems, you should follow the following cable suggestions:

- 1 Use cables no longer than 12 meters for Ultra3, Ultra160, and Ultra320 devices. (It's better to use shorter cables, if possible.)
- 1 Make sure the cables meet the specifications.
- 1 Use active termination.
- 1 **Note that cable stub length should be no more than 0.1 meter (4 inches).**
- 1 Route SCSI cables carefully and do not bend cables.
- 1 Use high impedance cables.
- 1 Do not mix cable types (choose either flat or rounded and shielded or non-shielded).
- 1 Note that ribbon cables have fairly good cross-talk rejection characteristics, meaning the signals on the different wires are less likely to interfere with each other.

Step 6 Set Target IDs

Set target identifiers (TIDs) on the SCSI devices. Each device in a channel must have a unique TID. Non-disk devices should have unique SCSI IDs *regardless of the channel where they are connected*. See the documentation for each SCSI device to set the TIDs. The RAID controller automatically occupies TID 7, which is the highest priority. The arbitration priority for a SCSI device depends on its TID. [Table 3-4](#) lists the target IDs.

NOTE: The RAID controller can occupy TID 6 in cluster mode. When in cluster mode, one controller is TID 6 and the other TID 7. IDs 0 - 7 are valid target IDs; 7 has the highest priority.

Table 3-4. Target IDs

Priority	Highest											Lowest	
TID	7	6	5	...	2	1	0	15	14	...	9	8	

Step 7 Set SCSI Termination

The SCSI bus is an electrical transmission line and must be terminated properly to minimize reflections and losses. Termination should be set at each end of the SCSI cable(s).

For a disk array, set SCSI bus termination so that removing or adding a SCSI device does not disturb termination. An easy way to do this is to connect the RAID controller to one end of the SCSI cable and an external terminator module at the other end of the cable, as shown in [Figure 3-6](#).

The connectors between the two ends can connect SCSI drives which have their termination disabled, as shown in the drives (ID0, ID1, ID2) attached in the figure. See the documentation for each SCSI drive to disable termination.

NOTE: Dell does not recommend mixing U160 and U320 drives on the same bus or logical drive.

Set the termination so that SCSI termination and TermPWR are intact when any hard drive is removed from a SCSI channel.

Figure 3-6. Terminating Internal SCSI Disk Array

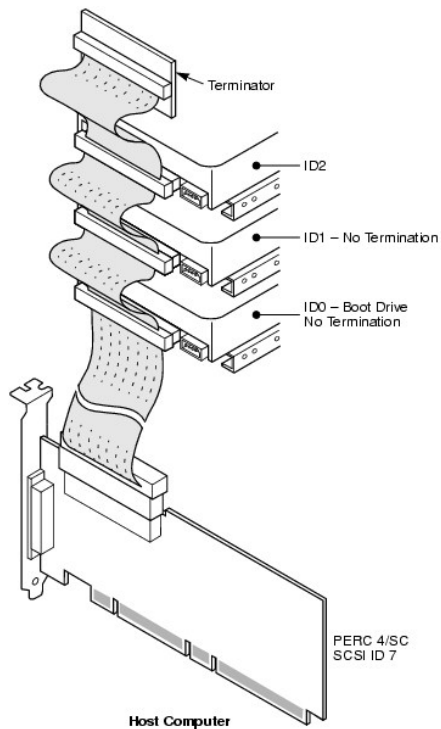

Step 8 Start the System

Replace the system cover and reconnect the AC power cords. Turn power on to the host system. Set up the power supplies so that the SCSI devices are powered up at the same time as or before the host system. If the system is powered up before a SCSI device, the device might not be recognized.

During bootup, the BIOS message appears:

```
PowerEdge Expandable RAID Controller BIOS Version x.xx date
```

```
Copyright (c) LSI Logic Corp.
```

```
Firmware Initializing... [ Scanning SCSI Device ...(etc)... ]
```

The firmware takes several seconds to initialize. During this time, the adapter scans the SCSI channel. When ready, the following appears:

```
HA -0 (Bus 1 Dev 6) Type: PERC 4/xx Standard FW x.xx SDRAM=xxxMB
```

```
Battery Module is Present on Adapter
```

```
0 Logical Drives found on the Host Adapter
```

```
0 Logical Drive(s) handled by BIOS
```

```
Press <Ctrl><M> to run PERC 4 BIOS Configuration Utility
```

The BIOS Configuration Utility prompt times out after several seconds.

The host controller number, firmware version, and cache SDRAM size display in the second portion of the BIOS message. The numbering of the controllers follows the PCI slot scanning order used by the host motherboard.

Light-emitting Diode (LED) Description

When you start the system, the boot block and firmware perform a number of steps that load the operating system and allow the system to function properly. The boot block contains the operating system loader and other basic information needed during startup.

As the system boots, the LEDs indicate the status of the boot block and firmware initialization and whether the system performed the steps correctly. If there is an error during startup, you can use the LED display to identify it.

[Table 3-5](#) displays the LEDs and execution states for the boot block. [Table 3-6](#) displays the LEDs and execution states during firmware initialization. The LEDs display in hexadecimal format so that you can determine the number and the corresponding execution state from the LEDs that display.

Table 3-5. Boot Block States

LED	Execution State
0x01	Setup 8-bit Bus for access to Flash and 8-bit devices successful

0x03	Serial port initialization successful
0x04	Spd (cache memory) read successful
0x05	SDRAM refresh initialization sequence successful
0x07	Start ECC initialization and memory scrub
0x08	End ECC initialization and memory scrub
0x10	SDRAM is present and properly configured. About to program ATU.
0x11	CRC check on the firmware image successful. Continue to load firmware.
0x12	Initialization of SCSI chips successful.
0x13	BIOS protocols ports initialized. About to load firmware.
0x17	Firmware is either corrupt or BIOS disabled. Firmware was not loaded.
0x19	Error ATU ID programmed.
0x55	System Halt: Battery Backup Failure

Table 3-6. Firmware Initialization States

LED	Execution State
0x1	Begin Hardware Initialization
0x3	Begin Initialize ATU
0x7	Begin Initialize Debug Console
0xF	Set if Serial Loopback Test is successful

Step 9 Run the BIOS Configuration Utility or Dell Manager

Press <Ctrl><M> when prompted during the boot process to run the BIOS Configuration Utility. You can run Dell Manager in Red Hat Linux to perform the same functions, such as configuring arrays and logical drives.

See [BIOS Configuration Utility and Dell Manager](#) for additional information about running the BIOS Configuration Utility and Dell Manager.

Step 10 Install an Operating System

Install one of the following operating systems: Microsoft® Windows® 2000, Windows 2003, Novell® NetWare®, and Red Hat Linux.

Step 11 Install the Operating System Driver

Operating system drivers are provided on the *Dell OpenManage Server Assistant* CD that accompanies your PERC controller. See the *CERC and PERC RAID Controllers Operating System Driver Installation Guide* for additional information about installing the drivers for the operating systems.

 **NOTE:** To make sure you have the latest version of the drivers, download the updated drivers from the Dell Support website at support.dell.com.

[Back to Contents Page](#)

[Back to Contents Page](#)

Configuring the RAID Controller

Dell™ PowerEdge™ Expandable RAID Controller 4/SC, 4/DC, and 4e/DC User's Guide

- [Configuring SCSI Physical Drives](#)
- [Physical Device Layout](#)
- [Device Configuration](#)
- [Setting Hardware Termination](#)
- [Configuring Arrays](#)
- [Assigning RAID Levels](#)
- [Optimizing Storage](#)
- [Planning the Array Configuration](#)

This section describes how to configure for physical drives, arrays, and logical drives. It contains tables you can complete to list the configuration for the physical drives and logical drives.

Configuring SCSI Physical Drives

Your SCSI hard drives must be organized into logical drives in an array and must be able to support the RAID level that you select.

Observe the following guidelines when connecting and configuring SCSI devices in a RAID array:

- 1 You can place up to 28 physical drives in an array.
- 1 Use drives of the same size and speed to maximize the effectiveness of the controller.
- 1 When replacing a failed drive in a redundant array, make sure that the replacement drive has the same or larger capacity than the smallest drive in the array (RAID 1, 5, 10, and 50).

 **NOTE:** For RAID levels 10 and 50, the additional space in larger arrays can store data, so you can use arrays of different sizes.

When implementing RAID 1 or RAID 5, disk space is spanned to create the stripes and mirrors. The span size can vary to accommodate the different disk sizes. There is, however, the possibility that a portion of the largest disk in the array will be unusable, resulting in wasted disk space. For example, consider a RAID 1 array that has the following disks, as shown in [Table 4-1](#).

Table 4-1. Storage Space in a RAID 1 Array

Disk	Disk Size	Storage Space Used in Logical Drive for RAID 1 Array	Storage Space Left Unused
A	20 GB	20 GB	0
B	30 GB	20 GB	10 GB

In this example, data is mirrored across the two disks until 20 GB on Disk A and B are completely full. This leaves 10 GB of disk space on Disk B. Data cannot be written to this remaining disk space, as there is no corresponding disk space available in the array to create redundant data.

[Table 4-2](#) provides an example of a RAID 5 array.

Table 4-2. Storage Space in a RAID 5 Array

Disk	Disk Size	Storage Space Used in Logical Drive for RAID 5 Array	Storage Space Left Unused
A	40 GB	40 GB	0 GB
B	40 GB	40 GB	0 GB
C	60 GB	40 GB	20 GB

In this example, data is striped across the disks until 40 GB on Disks A, B, and C are completely full. This leaves 20 GB of disk space on Disk C. Data cannot be written to this remaining disk space, as there is no corresponding disk space available in the array to create redundant data.

Physical Device Layout

Use [Table 4-3](#) to list the details for each physical device on the channels.

Table 4-3. Physical Device Layout

	Channel 0	Channel 1
Target ID		
Device type		
Logical drive number/ drive number		
Manufacturer/model number		
Firmware level		
Target ID		
Device type		
Logical drive number/ drive number		
Manufacturer/model number		
Firmware level		
Target ID		
Device type		
Logical drive number/ drive number		
Manufacturer/model number		
Firmware level		
Target ID		
Device type		
Logical drive number/drive number		
Manufacturer/model number		
Firmware level		
Target ID		
Device type		
Logical drive number/drive number		
Manufacturer/model number		
Firmware level		
Target ID		
Device type		
Logical drive number/drive number		
Manufacturer/model number		
Firmware level		
Target ID		
Device type		
Logical drive number/drive number		
Manufacturer/model number		
Firmware level		
Target ID		
Device type		
Logical drive number/drive number		
Manufacturer/model number		
Firmware level		
Target ID		
Device type		
Logical drive number/drive number		
Manufacturer/model number		
Firmware level		
Target ID		
Device type		
Logical drive number/drive number		
Manufacturer/model number		
Firmware level		
Target ID		
Device type		
Logical drive number/drive number		
Manufacturer/model number		
Firmware level		
Target ID		
Device type		
Logical drive number/drive number		
Manufacturer/model number		
Firmware level		
Target ID		
Device type		
Logical drive number/drive number		
Manufacturer/model number		
Firmware level		
Target ID		
Device type		
Logical drive number/drive number		
Manufacturer/model number		
Firmware level		
Target ID		
Device type		
Logical drive number/drive number		
Manufacturer/model number		
Firmware level		
Target ID		
Device type		
Logical drive number/drive number		
Manufacturer/model number		
Firmware level		
Target ID		
Device type		
Logical drive number/drive number		
Manufacturer/model number		
Firmware level		
Target ID		
Device type		
Logical drive number/drive number		
Manufacturer/model number		
Firmware level		
Target ID		
Device type		
Logical drive number/drive number		
Manufacturer/model number		
Firmware level		
Target ID		
Device type		
Logical drive number/drive number		
Manufacturer/model number		
Firmware level		
Target ID		
Device type		
Logical drive number/drive number		
Manufacturer/model number		
Firmware level		
Target ID		
Device type		
Logical drive number/drive number		
Manufacturer/model number		
Firmware level		
Target ID		
Device type		
Logical drive number/drive number		
Manufacturer/model number		
Firmware level		
Target ID		
Device type		
Logical drive number/drive number		
Manufacturer/model number		
Firmware level		

Device type		
Logical drive number/drive number		
Manufacturer/model number		
Firmware level		
Target ID		
Device type		
Logical drive number/drive number		
Manufacturer/model number		
Firmware level		
Target ID		
Device type		
Logical drive number/drive number		
Manufacturer/model number		
Firmware level		
Target ID		
Device type		
Logical drive number/drive number		
Manufacturer/model number		
Firmware level		
Target ID		
Device type		
Logical drive number/drive number		
Manufacturer/model number		
Firmware level		

Device Configuration

The following contain tables you can fill out to list the devices assigned to each channel. The PERC 4/SC controller has one channel; the PERC 4/DC and 4e/DC have two.

Use [Table 4-4](#) to list the devices that you assign to each SCSI ID for SCSI Channel 0.

Table 4-4. Configuration for SCSI Channel 0

SCSI Channel 0	
SCSI ID	Device Description
0	
1	
2	
3	
4	
5	
6	
7	Reserved for host controller.
8	
9	
10	
11	
12	
13	
14	
15	

Use [Table 4-5](#) to list the devices that you assign to each SCSI ID for SCSI Channel 1.

Table 4-5. Configuration for SCSI Channel 1

SCSI Channel 1	
SCSI ID	Device Description
0	
1	
2	
3	
4	
5	
6	
7	Reserved for host controller.
8	
9	
10	
11	
12	
13	
14	
15	

Setting Hardware Termination

 **NOTE:** If you are using the PERC 4/DC RAID controller for clustering, then you must use hardware termination. Otherwise, software termination is OK.

The SCSI bus is an electrical transmission line and must be terminated properly to minimize reflections and losses. Termination should be set at each end of the SCSI cable(s). For PERC 4e/DC, the following headers specify control of the SCSI termination:

- 1 J5 Termination Enable is a three-pin header that specifies control of the SCSI termination for channel 0.
- 1 J6 Termination Enable is a three-pin header that specifies control of the SCSI termination for channel 1.

To enable hardware termination, leave the pins open. The default is hardware termination.

 **NOTE:** See [Step 7 Set SCSI Termination](#) for additional information about setting SCSI termination.

Configuring Arrays

After you configure and initialize the hard drives, you are ready to configure arrays. The number of drives in an array determines the RAID levels that can be supported.

For information about the number of drives required for different RAID levels, see [Table 4-7](#) in [Assigning RAID Levels](#).

Spanned Drives

You can arrange arrays sequentially with an identical number of drives so that the drives in the different arrays are spanned. Spanned drives can be treated as one large drive. Data can be striped across multiple arrays as one logical drive.

You can create spanned drives using your array management software.

Hot Spares

Any hard drive that is present, formatted, and initialized, but is not included in an array or logical drive, can be designated as a hot spare. A hot spare should have the same or greater capacity than the smallest physical disk in the array it protects. You can designate hard drives as hot spares using your array management software.

Logical Drives

Logical drives, also known as virtual disks, are arrays or spanned arrays that are available to the operating system. The storage space in a logical drive is spread across all the physical drives in the array or spanned arrays.

You must create one or more logical drives for each array, and the logical drive capacity must include all of the drive space in an array. You can make the logical drive capacity larger by spanning arrays. In an array of drives with mixed sizes, the smallest common drive size is used and the space in larger drives is not used. The RAID controller supports up to 40 logical drives.

Configuration Strategies

The most important factors in RAID array configuration are:

- 1 Drive capacity
- 1 Drive availability (fault tolerance)
- 1 Drive performance

You cannot configure a logical drive that optimizes all three factors, but it is easy to choose a logical drive configuration that maximizes one factor at the expense of the other two factors. For example, RAID 1 (mirroring) provides excellent fault tolerance, but requires a redundant drive.

Configuring Logical Drives

After you have attached all physical drives, perform the following steps to prepare a logical drive. If the operating system is not yet installed, use the BIOS Configuration Utility to perform this procedure. If the operating system is installed, you can use the Dell Manager for Linux or OpenManage Array Manager (for Windows and Netware), depending on the operating system.

1. Start the system.
2. Run your array management software.
3. Select the option to customize the RAID array.

In the BIOS Configuration Utility and Dell Manager for Linux, use either **Easy Configuration** or **New Configuration** to customize the RAID array.

 **CAUTION:** If you select **New Configuration**, all previous configuration information will be deleted.

4. Create and configure one or more system drives (logical drives).
5. Select the RAID level, cache policy, read policy, and write policy.

 **NOTE:** Refer to the section [Summary of RAID Levels](#) for RAID level explanations.

6. Save the configuration.
7. Initialize the system drives.

After initialization, you can install the operating system.

See [BIOS Configuration Utility and Dell Manager](#) for detailed configuration instructions.

Logical Drive Configuration

Use [Table 4-6](#) to list the details for each logical drive that you configure.

Table 4-6. Logical Drive Configuration

Logical Drive	RAID Level	Stripe Size	Logical Drive Size	Cache Policy	Read Policy	Write Policy	Number of Physical Drives
LD0							
LD1							
LD2							
LD3							
LD4							
LD5							
LD6							
LD7							
LD8							
LD9							
LD10							
LD11							
LD12							
LD13							
LD14							
LD15							
LD16							
LD17							
LD18							
LD19							
LD20							
LD21							
LD22							
LD23							
LD24							
LD25							
LD26							
LD27							
LD28							
LD29							
LD30							
LD31							
LD32							
LD33							
LD34							
LD35							
LD36							
LD37							
LD38							
LD39							

Assigning RAID Levels

Only one RAID level can be assigned to each logical drive. [Table 4-7](#) shows the minimum and maximum number of drives required.

Table 4-7. Physical Drives Required for Each RAID Level

RAID Level	Minimum # of Physical Drives	Maximum # of Physical Drives for PERC 4/SC	Maximum # of Physical Drives for PERC 4/DC and 4e/DC
0	1	14	28
1	2	2	2
5	3	14	28
10	4	14	28
50	6	14	28

Summary of RAID Levels

RAID 0 uses striping to provide high data throughput, especially for large files in an environment that does not require fault tolerance.

RAID 1 uses mirroring and is good for small databases or other applications that require small capacity, but complete data redundancy.

RAID 5 provides high data throughput, especially for small random access. Use this level for any application that requires high read request rates, but low write request rates, such as transaction processing applications. Write performance is significantly lower for RAID 5 than for RAID 0 and RAID 1.

RAID 10 consists of striped data across mirrored spans. It provides high data throughput and complete data redundancy, but uses a larger number of spans.

RAID 50 uses parity and disk striping and works best with data that requires high reliability, high request rates, high data transfers, and medium-to-large capacity. Write performance is limited to the same as RAID 5.

Storage in an Array with Drives of Different Sizes

For RAID levels 0 and 5, data is striped across the disks. If the hard drives in an array are not the same size, data is striped across all the drives until one or more of the drives is full. After one or more drives are full, disk space left on the other disks cannot be used. Data cannot be written to that disk space because other drives do not have corresponding disk space available.

[Figure 4-1](#) shows an example of storage allocation in a RAID 5 array. The data is striped, with parity, across the three drives until the smallest drive is full. The remaining storage space in the other hard drives cannot be used because not all of the drives have disk space for redundant data.

Figure 4-1. Storage in a RAID 5 Array

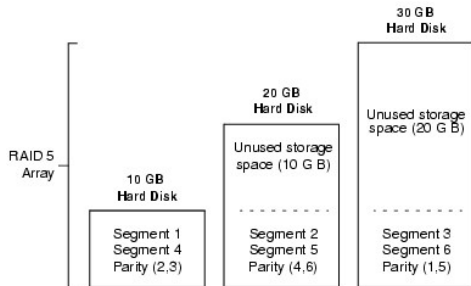

Storage in RAID 10 and RAID 50 Arrays

You can span RAID 1 and 5 arrays to create RAID 10 and RAID 50 arrays, respectively. For RAID levels 10 and 50, you can have some arrays with more storage space than others. After the storage space in the smaller arrays is full, you can use the additional space in larger arrays to store data.

Figure 4-2 shows the example of a RAID 50 span with three RAID 5 arrays of different sizes. (Each array can have from three to 14 hard disks.) Data is striped across the three RAID 5 arrays until the smallest array is full. The data is striped across the remaining two RAID 5 arrays until the smaller of the two arrays is full. Finally, data is stored in the additional space in the largest array.

Figure 4-2. Storage in a RAID 50 Array

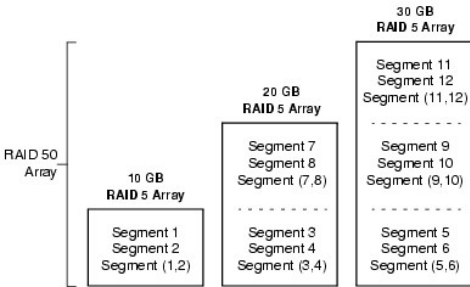

Performance Considerations

The system performance improves as the number of spans increases. As the storage space in the spans is filled, the system stripes data over fewer and fewer spans and RAID performance degrades to that of a RAID 1 or RAID 5 array.

Optimizing Storage

Data Access Requirements

Each type of data stored in the disk subsystem has a different frequency of read and write activity. If you know the data access requirements, you can more successfully determine a strategy for optimizing the disk subsystem capacity, availability, and performance.

Servers that support video on demand typically read the data often, but write data infrequently. Both the read and write operations tend to be long. Data stored on a general-purpose file server involves relatively short read and write operations with relatively small files.

Array Functions

Define the major purpose of the disk array by answering questions such as the following, which are followed by suggested RAID levels for each situation:

- 1 Will this disk array increase the system storage capacity for general-purpose file and print servers? Use RAID 5, 10, or 50.
- 1 Does this disk array support any software system that must be available 24 hours per day? Use RAID 1, 5, 10, or 50.
- 1 Will the information stored in this disk array contain large audio or video files that must be available on demand? Use RAID 0.
- 1 Will this disk array contain data from an imaging system? Use RAID 0 or 10.

Planning the Array Configuration

Fill out [Table 4-8](#) to help you plan the array configuration. Rank the requirements for your array, such as storage space and data redundancy, in order of importance, then review the suggested RAID levels. Refer to [Table 4-7](#) for the minimum and maximum number of drives allowed per RAID level.

Table 4-8. Factors to Consider for Array Configuration

Requirement	Rank	Suggested RAID Level(s)
-------------	------	-------------------------

Storage space	RAID 0, RAID 5
Data redundancy	RAID 5, RAID 10, RAID 50
Hard drive performance and throughput	RAID 0, RAID 10
Hot spares (extra hard drives required)	RAID 1, RAID 5, RAID 10, RAID 50

[Back to Contents Page](#)

[Back to Contents Page](#)

BIOS Configuration Utility and Dell Manager

Dell™ PowerEdge™ Expandable RAID Controller 4/SC, 4/DC, and 4e/DC User's Guide

- [Starting the BIOS Configuration Utility](#)
- [Starting Dell Manager](#)
- [Using Dell Manager in Red Hat Linux GUI Mode](#)
- [Configuring Arrays and Logical Drives](#)
- [Designating Drives as Hot Spares](#)
- [Creating Arrays and Logical Drives](#)
- [Drive Roaming](#)
- [Initializing Logical Drives](#)
- [Deleting Logical Drives](#)
- [Clearing Physical Drives](#)
- [Rebuilding Failed Hard Drives](#)
- [Using a Pre-loaded SCSI Drive "As-is"](#)
- [FlexRAID Virtual Sizing](#)
- [Checking Data Consistency](#)
- [Reconstructing Logical Drives](#)
- [Exiting the Configuration Utility](#)

The BIOS Configuration Utility configures disk arrays and logical drives. Because the utility resides in the RAID controller BIOS, its operation is independent of the operating systems on your system.

Dell™ Manager is a character-based, non-GUI utility that changes policies, and parameters, and monitors RAID systems. Dell Manager runs under Red Hat® Enterprise Linux, Advanced Server edition and Enterprise edition.

 **NOTE:** The OpenManage™ Array Manager can perform many of the same tasks as the BIOS Configuration Utility and Dell Manager.

Use these utilities to do the following:

- 1 Create hot spare drives.
- 1 Configure physical arrays and logical drives.
- 1 Initialize one or more logical drives.
- 1 Access controllers, logical drives, and, physical drives individually.
- 1 Rebuild failed hard drives.
- 1 Verify that the redundancy data in logical drives using RAID level 1, 5, 10, or 50 is correct.
- 1 Reconstruct logical drives after changing RAID levels or adding a hard drive to an array.
- 1 Select a host controller to work on.

The BIOS Configuration Utility and the Dell Manager for Linux use the same command structure to configure controllers and disks. The following sections describe the steps to start either utility and detailed instructions to perform configuration steps using either utility.

 **NOTE:** Dell Manager screens differ slightly from the BIOS Configuration Utility screens, but the utilities have similar functions.

Starting the BIOS Configuration Utility

When the host computer boots, hold the <Ctrl> key and press the <M> key when a BIOS banner such as the following appears:

```
HA -0 (Bus X Dev X) Type: PERC 4 Standard FWx.xx SDRAM=128MB
```

```
Battery Module is Present on Adapter
```

1 Logical Drive found on the Host Adapter

Adapter BIOS Disabled, No Logical Drives handled by BIOS

0 Logical Drive(s) handled by BIOS

Press <Ctrl><M> to Enable BIOS

For each controller in the host system, the firmware version, dynamic random access memory (DRAM) size, and the status of logical drives on that controller display. After you press a key to continue, the **Management Menu** screen displays.

 **NOTE:** In the BIOS Configuration Utility, pressing <Ctrl><M> has the same effect as pressing <Enter>.

 **NOTE:** You can access multiple controllers through the BIOS Configuration Utility. Be sure to verify which controller you are currently set to edit.

Starting Dell Manager

Make sure the program file is in the correct directory before you enter the command to start Dell Manager. For Linux, use the Dell Manager RPM to install files in the `usr/sbin` directory. The RPM installs them automatically in that directory.

Type `dellmgr` to start the program.

Using Dell Manager in Red Hat Linux GUI Mode

On a system running Red Hat Linux, for Dell Manager to work correctly in a terminal in GUI Mode, you must set the terminal type to `linux` and keyboard mappings.

Perform the procedure below if you use `konsole`, `gnome terminal`, or `xterm`.

The Linux console mode, which you select from the terminal with the **File → Linux Console** command, works correctly by default. The text mode console (non-GUI) also works correctly by default.

To prepare the system to use Dell Manager, perform the following steps:

1. Start the Terminal.
2. Before you enter `dellmgr` to start Dell Manager, type the following commands:

```
TERM=linux
```

```
Export TERM
```

3. Select **Settings→ Keyboard→ Linux Console** from the Terminal menu.

 **NOTE:** On a Red Hat Enterprise Linux system, when you run Dell Manager (v. x.xx) from a Gnome- terminal in XWindows, the <F10> key cannot be used to create a logical drive. Instead, use the alternate keys <Shift><0>. (This is not an issue if Xterm is used to call `dellmgr`). The following is a list of alternate keys you can use in case of problems with keys <F1> through <F7>, and <F10>:

1 <Shift><1> for <F1>

- 1 <Shift><2> for <F2>
 - 1 <Shift><3> for <F3>
 - 1 <Shift><4> for <F4>
 - 1 <Shift><5> for <F5>
 - 1 <Shift><6> for <F6>
 - 1 <Shift><7> for <F7>
 - 1 <Shift><0> for <F10>
-

Configuring Arrays and Logical Drives

The following procedures apply to both the BIOS Configuration Utility and the Dell Manager for Linux.

1. Designate hot spares (optional).

See [Designating Drives as Hot Spares](#) in this section for more information.

2. Select a configuration method.

See [Creating Arrays and Logical Drives](#) in this section for more information.

3. Create arrays using the available physical drives.
4. Define logical drives using the arrays.
5. Save the configuration information.
6. Initialize the logical drives.

See [Initializing Logical Drives](#) in this section for more information.

Designating Drives as Hot Spares

Hot spares are physical drives that are powered up along with the RAID drives and usually stay in a standby state. If a hard drive used in a RAID logical drive fails, a hot spare will automatically take its place and the data on the failed drive is reconstructed on the hot spare. Hot spares can be used for RAID levels 1, 5, 10, and 50. Each controller supports up to eight hot spares.

 **NOTE:** In the BIOS Configuration Utility and Dell Manager, only global hot spares can be assigned. Dedicated hot spares cannot be assigned.

The methods for designating physical drives as hot spares are:

- 1 Pressing <F4> while creating arrays in **Easy**, **New** or **View/Add Configuration** mode.
- 1 Using the **Objects—> Physical Drive** menu.

<F4> Key

When you select any configuration option, a list of all physical devices connected to the current controller appears. Perform the following steps to designate a drive as a hot spare:

1. On the **Management Menu** select **Configure**, then a configuration option.
2. Press the arrow keys to highlight a hard drive that displays as **READY**.
3. Press <F4> to designate the drive as a hot spare.
4. Click **YES** to make the hot spare.

The drive displays as **HOTSP**.

5. Save the configuration.

Objects Menu

1. On the **Management Menu** select **Objects**—> **Physical Drive**.

A physical drive selection screen appears.

2. Select a hard drive in the **READY** state and press <Enter> to display the action menu for the drive.
3. Press the arrow keys to select **Make HotSpare** and press <Enter>.



The selected drive displays as **HOTSP**.

Creating Arrays and Logical Drives

Configure arrays and logical drives using **Easy Configuration**, **New Configuration**, or **View/Add Configuration**. See [Using Easy Configuration](#), [Using New Configuration](#), or [Using View/Add Configuration](#) for the configuration procedures.

After you create an array or arrays, you can select the parameters for the logical drive. [Table 5-1](#) contains descriptions of the parameters.

Table 5-1. Logical Drive Parameters and Descriptions

Parameter	Description
RAID Level	The number of physical drives in a specific array determines the RAID levels that can be implemented with the array.
Stripe Size	<p>Stripe Size specifies the size of the segments written to each drive in a RAID 1, 5, or 10 logical drive. You can set the stripe size to 8 KB, 16 KB, 32 KB, 64 KB, or 128 KB. The default is 64 KB.</p> <p>A larger stripe size provides better read performance, especially if your computer does mostly sequential reads. However, if you are sure that your computer does random read requests more often, select a small stripe size.</p>
Write Policy	<p>Write Policy specifies the cache write policy. You can set the write policy to Write-back or Write-through.</p> <p>In Write-back caching, the controller sends a data transfer completion signal to the host when the controller cache has received all the data in a transaction. This setting is recommended in standard mode.</p> <p> NOTICE: If WriteBack is enabled and the system is quickly turned off and on, the RAID controller may hang when flushing cache memory. Controllers that contain a battery backup will default to WriteBack caching.</p> <p>In Write-through caching, the controller sends a data transfer completion signal to the host when the disk subsystem has received all the data in a transaction.</p> <p>Write-through caching has a data security advantage over write-back caching. Write-back caching has a performance advantage over write-through caching.</p> <p> NOTE: You should not use write-back for any logical drive that is to be used as a <i>Novell NetWare volume</i>.</p> <p> NOTE: Enabling clustering turns off write cache. PERC 4/DC and PERC 4e/DC support clustering.</p>
Read Policy	<p>Read-ahead enables the read-ahead feature for the logical drive. You can set this parameter to Read-Ahead, No-Read-ahead, or Adaptive. The default is Adaptive.</p> <p>Read-ahead specifies that the controller uses read-ahead for the current logical drive. Read-ahead capability allows the adapter to read sequentially ahead of requested data and store the additional data in cache memory, anticipating that the data will be needed soon. Read-ahead supplies sequential data faster, but is not as effective when accessing random data.</p> <p>No-Read-Ahead specifies that the controller does not use read-ahead for the current logical drive.</p> <p>Adaptive specifies that the controller begins using read-ahead if the two most recent disk accesses occurred in sequential sectors. If all read requests are random, the algorithm reverts to No-Read-Ahead; however, all requests are still evaluated for possible sequential operation.</p>
Cache Policy	<p>Cache Policy applies to reads on a specific logical drive. It does not affect the Read-ahead cache. The default is Direct I/O.</p> <p>Cached I/O specifies that all reads are buffered in cache memory.</p>

	Direct I/O specifies that reads are not buffered in cache memory. Direct I/O does not override the cache policy settings. Data is transferred to cache and the host concurrently. If the same data block is read again, it comes from cache memory.
Span	<p>The choices are:</p> <p>Yes—Array spanning is enabled for the current logical drive. The logical drive can occupy space in more than one array.</p> <p>No—Array spanning is disabled for the current logical drive. The logical drive can occupy space in only one array.</p> <p>The RAID controller supports spanning of RAID 1 and 5 arrays. You can span two or more RAID 1 arrays into a RAID 10 array and two or more RAID 5 arrays into a RAID 50 array.</p> <p>For two arrays to be spanned, they must have the same stripe width (they must contain the same number of physical drives).</p>

Using Easy Configuration

In **Easy Configuration**, each physical array you create is associated with exactly one logical drive. You can modify the following parameters:

- 1 RAID level
- 1 Stripe size
- 1 Write policy
- 1 Read policy
- 1 Cache policy

If logical drives have already been configured when you select **Easy Configuration**, the configuration information is not disturbed. Perform the following steps to create arrays and logical drives using **Easy Configuration**.

1. Select **Configure**—> **Easy Configuration** from the **Management Menu**.

Hot key information displays at the bottom of the screen.

2. Press the arrow keys to highlight specific physical drives.
3. Press the spacebar to associate the selected physical drive with the current array.

The selected drive changes from **READY** to **ONLIN A[array number]-[drive number]**. For example, **ONLIN A02-03** means array 2 with hard drive 3.

4. Add physical drives to the current array as desired.

Try to use drives of the same capacity in a specific array. If you use drives with different capacities in an array, all drives in the array are treated as if they have the capacity of the smallest drive in the array.

5. Press <Enter> after you finish creating the current array.

The **Select Configurable Array(s)** window appears. It displays the array and array number, such as **A-00**.

6. Press the spacebar to select the array.

 **NOTE:** You can press <F2> to display the number of drives in the array, their channel and ID, and press <F3> to display array information, such as the stripes, slots, and free space.

7. Press <F10> to configure logical drives.

The window at the top of the screen shows the logical drive that is currently being configured.

8. Highlight **RAID** and press <Enter> to set the RAID level for the logical drive.

The available RAID levels for the current logical drive display.

9. Select a RAID level and press <Enter> to confirm.
10. Click **Advanced Menu** to open the menu for logical drive settings.
11. Set the **Stripe Size**.
12. Set the **Write Policy**.

13. Set the **Read Policy**.
14. Set the **Cache Policy**.
15. Press <Esc> to exit the **Advanced Menu**.
16. After you define the current logical drive, select **Accept** and press <Enter>.

The array selection screen appears if any unconfigured hard drives remain.

17. Repeat [step 2](#) through [step 16](#) to configure another array and logical drive.

The RAID controller supports up to 40 logical drives per controller.

18. When finished configuring logical drives, press <Esc> to exit **Easy Configuration**.

A list of the currently configured logical drives appears.

19. Respond to the **Save** prompt.

After you respond to the prompt, the **Configure** menu appears.

20. Initialize the logical drives you have just configured.

See [Initializing Logical Drives](#) in this section for more information.

Using New Configuration

If you select **New Configuration**, the existing configuration information on the selected controller is *destroyed when the new configuration is saved*. In **New Configuration**, you can modify the following logical drive parameters:

- 1 RAID level
- 1 Stripe size
- 1 Write policy
- 1 Read policy
- 1 Cache policy
- 1 Logical drive size
- 1 Spanning of arrays

 **NOTICE:** Selecting **New Configuration** *erases* the existing configuration information on the selected controller. To use the existing configuration, use **View/Add Configuration**.

1. Select **Configure**—> **New Configuration** from the **Management Menu**.

Hot key information appears at the bottom of the screen.

2. Press the arrow keys to highlight specific physical drives.
3. Press the spacebar to associate the selected physical drive with the current array.

The selected drive changes from **READY** to **ONLINE A[*array number*]-[*drive number*]**. For example, **ONLINE A02-03** means array 2 with hard drive 3.

4. Add physical drives to the current array as desired.

 **NOTE:** Try to use drives of the same capacity in a specific array. If you use drives with different capacities in an array, all drives in the array are treated as if they have the capacity of the smallest drive in the array.

5. Press <Enter> twice after you finish creating the current array.

The **Select Configurable Array(s)** window appears. It displays the array and array number, such as **A-00**.

6. Press the spacebar to select the array.

Span information displays in the array box. You can create multiple arrays, then select them to span them.

 **NOTE:** You can press <F2> to display the number of drives in the array, their channel and ID, and <F3> to display array information, such as the stripes, slots, and free space.

7. Repeat [step 2](#) through [step 6](#) to create another array or go to [step 8](#) to configure a logical drive.
8. Press <F10> to configure a logical drive.

The logical drive configuration screen appears. **Span=Yes** displays on this screen if you select two or more arrays to span.

The window at the top of the screen shows the logical drive that is currently being configured as well as any existing logical drives.

9. Highlight **RAID** and press <Enter> to set the RAID level for the logical drive.

A list of the available RAID levels for the current logical drive appears.

10. Select a RAID level and press <Enter> to confirm.
11. Highlight **Span** and press <Enter>.
12. Highlight a spanning option and press <Enter>.

 **NOTE:** The PERC 4 family supports spanning for RAID 1 and RAID 5 only. You can configure RAID 10 by spanning two or more RAID 1 logical drives. You can configure RAID 50 by spanning two or more RAID 5 logical drives. The logical drives must have the same stripe size.

13. Move the cursor to **Size** and press <Enter> to set the logical drive size.

 **NOTE:** The full drive size is used when you span logical drives; you cannot specify a smaller drive size.

By default, the logical drive size is set to all available space in the array(s) being associated with the current logical drive, accounting for the **Span** setting.

14. Click **Advanced Menu** to open the menu for logical drive settings.
15. Set the **Stripe Size**.
16. Set the **Write Policy**.
17. Set the **Read Policy**.
18. Set the **Cache Policy**.
19. Press <Esc> to exit the **Advanced Menu**.
20. After you define the current logical drive, select **Accept** and press <Enter>.

If space remains in the arrays, the next logical drive to be configured appears. If the array space has been used, a list of the existing logical drives appears.

21. Press any key to continue, then respond to the **Save** prompt.
22. Initialize the logical drives you have just configured.

See [Initializing Logical Drives](#) in this section for more information.

Using View/Add Configuration

View/Add Configuration allows you to control the same logical drive parameters as **New Configuration** *without disturbing* the existing configuration information. In addition, you can enable the **Configuration on Disk** feature.

1. Select **Configure**—> **View/Add Configuration** from the **Management Menu**.

Hot key information appears at the bottom of the screen.

2. Press the arrow keys to highlight specific physical drives.
3. Press the spacebar to associate the selected physical drive with the current array.

The selected drive changes from **READY** to **ONLIN A[*array number*]-[*drive number*]**. For example, **ONLIN A02-03** means array 2 with hard drive 3.

4. Add physical drives to the current array as desired.

 **NOTE:** Try to use drives of the same capacity in a specific array. If you use drives with different capacities in an array, all drives in the array are treated as if they have the capacity of the smallest drive in the array.

5. Press <Enter> twice after you finish creating the current array.

The **Select Configurable Array(s)** window appears. It displays the array and array number, such as **A-00**.

6. Press the spacebar to select the array.

Span information, such as **Span-1**, displays in the array box. You can create multiple arrays, then select them to span them.

 **NOTE:** You can press <F2> to display the number of drives in the array, their channel and ID, and <F3> to display array information, such as the stripes, slots, and free space.

7. Press <F10> to configure a logical drive.

The logical drive configuration screen appears. **Span=Yes** displays on this screen if you select two or more arrays to span.

8. Highlight **RAID** and press <Enter> to set the RAID level for the logical drive.

The available RAID levels for the current logical drive appear.

9. Select a RAID level and press <Enter> to confirm.
10. Highlight **Span** and press <Enter>.
11. Highlight a spanning option and press <Enter>.
12. Move the cursor to **Size** and press <Enter> to set the logical drive size.

By default, the logical drive size is set to all available space in the array(s) associated with the current logical drive, accounting for the **Span** setting.

13. Highlight **Span** and press <Enter>.
14. Highlight a spanning option and press <Enter>.

 **NOTE:** The full drive size is used when you span logical drives; you cannot specify a smaller drive size.

15. Open the **Advanced Menu** to open the menu for logical drive settings.
16. Set the **Stripe Size**.
17. Set the **Write Policy**.
18. Set the **Read Policy**.
19. Set the **Cache Policy**.
20. Press <Esc> to exit the **Advanced Menu**.
21. After you define the current logical drive, select **Accept** and press <Enter>.

If space remains in the arrays, the next logical drive to be configured appears.

22. Repeat [step 2](#) to [step 21](#) to create an array and configure another logical drive.

If all array space is used, a list of the existing logical drives appears.

23. Press any key to continue, then respond to the **Save** prompt.
24. Initialize the logical drives you have just configured.

See [Initializing Logical Drives](#) in this section for more information.

Drive Roaming

Drive roaming occurs when the hard drives are changed to different channels on the same controller or to different target IDs. When the drives are placed on different channels, the controller detects the RAID configuration from the configuration data on the drives. See [Drive Roaming](#) in the [RAID Controller Features](#) section for more information.

Initializing Logical Drives

Initialize each new logical drive you configure. You can initialize the logical drives individually or in batches (up to 40 simultaneously).

Batch Initialization

1. Select **Initialize** from the **Management Menu**.

A list of the current logical drives appears.

2. Press the spacebar to select the desired logical drive for initialization.
3. Press <F2> to select/deselect all logical drives.
4. After you finish selecting logical drives, press <F10> and select **Yes** from the confirmation prompt.

The progress of the initialization for each drive is shown in bar graph format.

5. When initialization is complete, press any key to continue or press <Esc> to display the **Management Menu**.

Individual Initialization

1. Select the **Objects—> Logical Drive** from the **Management Menu**.
2. Select the logical drive to be initialized.
3. Select **Initialize** from the action menu.

Initialization progress appears as a bar graph on the screen.

4. When initialization completes, press any key to display the previous menu.
-

Deleting Logical Drives

This RAID controller supports the ability to delete any unwanted logical drives and use that space for a new logical drive. You can have an array with multiple logical drives and delete a logical drive without deleting the whole array.

After you delete a logical drive, you can create a new one. You can use the configuration utilities to create the next logical drive from a free space ('hole'), and from the newly created arrays. The configuration utility provides a list of configurable arrays where there is a space to configure. In the BIOS Configuration Utility, you must create a logical drive in the hole before you create a logical drive using the rest of the disk.

 **NOTICE:** The deletion of the logical drive can fail under certain conditions: During a rebuild, initialization or check consistency of a logical drive.

To delete logical drives, perform the following steps:

1. Select **Objects—> Logical Drive** from the **Management Menu**.

The logical drives display.

2. Use the arrow key to highlight the logical drive you want to delete.
3. Press <F5> to delete the logical drive.

This deletes the logical drive and makes the space it occupied available for you to make another logical drive.

Clearing Physical Drives

You can clear the data from SCSI drives using the configuration utilities. To clear a drive, perform the following steps:

1. Select **Management Menu—> Objects—> Physical Drives** in the BIOS Configuration Utility.

A device selection window displays the devices connected to the current controller.

2. Press the arrow keys to select the physical drive to be cleared and press <Enter>.
3. Select **Clear**.
4. When clearing completes, press any key to display the previous menu.

 **NOTICE:** Do not terminate the clearing process, as it makes the drive unusable. You would have to clear the drive again before you could use it.

Displaying Media Errors

Check the **View Drive Information** screen for the drive to be formatted. Perform the following steps to display this screen which contains the media errors:

1. Select **Objects—> Physical Drives** from the **Management Menu**.
2. Select a device.
3. Press <F2>.

The error count displays at the bottom of the properties screen as they occur. If you feel that the number of errors is excessive, you should probably clear the hard drive. You do not have to select **Clear** to erase existing information on your SCSI disks, such as a DOS partition. That information is erased when you initialize logical drives.

Rebuilding Failed Hard Drives

If a hard drive fails in an array that is configured as a RAID 1, 5, 10, or 50 logical drive, you can recover the lost data by rebuilding the drive.

Rebuild Types

[Table 5-2](#) describes automatic and manual rebuilds.

Table 5-2. Rebuild Types

Type	Description
Automatic Rebuild	If you have configured hot spares, the RAID controller automatically tries to use them to rebuild failed disks. Select Objects—> Physical Drive to display the list of physical drives while a rebuild is in progress. The hot spare drive changes to REBLD A[array number]-drive number , indicating the hard drive is being replaced by the hot spare. For example, REBLD A01-02 indicates that the data is being rebuilt on hard drive 2 in array 1.
Manual Rebuild	Manual rebuild is necessary if no hot spares with enough capacity to rebuild the failed drives are available. You must insert a drive with enough storage into the subsystem before rebuilding the failed drive. Use the following procedures to rebuild a failed drive manually in individual or batch mode.

Manual Rebuild – Rebuilding an Individual Drive

1. Select **Objects—> Physical Drive** from the **Management Menu**.

A device selection window displays the devices connected to the current controller.

2. Designate an available drive as a hot spare before the rebuild starts.

See the section [Designating Drives as Hot Spares](#) for instructions on designating a hot spare.

3. Press the arrow keys to select the failed physical drive you want to rebuild, then press <Enter>.
4. Select **Rebuild** from the action menu and respond to the confirmation prompt.

Rebuilding can take some time, depending on the drive capacity.

5. When the rebuild is complete, press any key to display the previous menu.

Manual Rebuild – Batch Mode

1. Select **Rebuild** from the **Management Menu**.

A device selection window displays the devices connected to the current controller. The failed drives display as **FAIL**.

2. Press the arrow keys to highlight any failed drives to be rebuilt.
3. Press the spacebar to select the desired physical drive for rebuild.
4. After you select the physical drives, press <F10> and select **Yes** at the prompt.

The selected drives change to **REBLD**. Rebuilding can take some time, depending on the number of drives selected and the drive capacities.

5. When the rebuild is complete, press any key to continue.
6. Press <Esc> to display the **Management Menu**.

Using a Pre-loaded SCSI Drive "As-is"

 **NOTE:** To use a pre-loaded system drive in the manner described here, you must make it the first logical drive defined (for example: LD1) on the controller it is connected to. This will make the drive ID 0 LUN 0. If the drive is not a boot device, the logical drive number is not critical.

If you have a SCSI hard drive that is already loaded with software and the drive is a boot disk containing an operating system, add the PERC device driver to this system drive before you switch to the RAID controller and attempt to boot from it. Perform the following steps:

1. Connect the SCSI drive to the channel on the RAID controller, with proper termination and target ID settings.
2. Boot the computer.
3. Start the configuration utility by pressing <Ctrl><M>.
4. Select **Configure—> Easy Configuration**.
5. Press the cursor keys to select the pre-loaded drive.
6. Press the spacebar.

The pre-loaded drive should now become an array element.

7. Press <Enter>.

You have now declared the pre-loaded drive as a one-disk array.

8. Set the **Read Policy** and **Cache Policy** on the **Advanced Menu**.
9. Exit the **Advanced Menu**.
10. Highlight **Accept** and press <Enter>.

Do not initialize.

11. Press <Esc> and select **Yes** at the Save prompt.
12. Exit the configuration utility and reboot.
13. Set the host system to boot from SCSI, if such a setting is available.

FlexRAID Virtual Sizing

The **FlexRAID Virtual Sizing** option can no longer be enabled on PERC 4/SC or PERC 4/DC. This option allowed Windows® NT and Novell® NetWare® 5.1 to use the new space of a RAID array immediately after you added capacity online or performed a reconstruction.

 **NOTE:** FlexRAID virtual sizing is not supported on PERC 4e/DC.

FlexRAID Virtual Sizing is in the BIOS Configuration Utility. If you have this option enabled on older cards, you need to disable it, then upgrade the firmware. Perform the following steps to do this:

1. Go to the support.dell.com website.
2. Download the latest firmware and driver to a diskette or directly to your system.

The download is an executable file that generates the firmware files on bootable diskette.

3. Restart the system and boot from the diskette.
4. Run `pflash` to flash the firmware.

Checking Data Consistency

Select this option to verify the redundancy data in logical drives that use RAID levels 1, 5, 10, and 50. (RAID 0 does not provide data redundancy.)

The parameters of the existing logical drives appear. Discrepancies are automatically corrected when the data is correct. However, if the failure is a read error on a data drive, the bad data block is reassigned and the data is re-generated.

 **NOTE:** Dell recommends that you run periodic data consistency checks on a redundant array. This allows detection and automatic replacement of bad blocks. Finding a bad block during a rebuild of a failed drive is a serious problem, as the system does not have the redundancy to recover the data.

Perform the following steps to run **Check Consistency**:

1. Select **Check Consistency** from the **Management Menu**.
2. Press the arrow keys to highlight the desired logical drives.
3. Press the spacebar to select or deselect a drive for consistency checking.
4. Press <F2> to select or deselect all the logical drives.
5. Press <F10> to begin the consistency check.

A progress graph for each selected logical drive displays.

6. When the check is finished, press any key to clear the progress display.
7. Press <Esc> to display the Management Menu.

(To check an individual drive, select **Objects—> Logical Drives** from the **Management Menu**, the desired logical drive(s), then **Check Consistency** on the action menu.)

 **NOTE:** Stay at the **Check Consistency** menu until the check is complete.

Reconstructing Logical Drives

A reconstruction occurs when you change the RAID level of an array or add a physical drive to an existing array. Perform the following steps to reconstruct a drive:

1. Move the arrow key to highlight **Reconstruct** on the **Management Menu**.
2. Press <Enter>.

The window entitled "**Reconstructables**" displays. This contains the logical drives that can be reconstructed. You can press <F2> to view logical drive information or <Enter> to select the reconstruct option.

3. Press <Enter>.

The next reconstruction window displays. The options on this window are <spacebar> to select a drive, <Enter> to open the reconstruct menu, and <F3> to display logical drive information.

4. Press <Enter> to open the reconstruct menu.

The menu items are RAID level, stripe size, and reconstruct.

5. To change the RAID level, select **RAID** with the arrow key, and press <Enter>.
6. Select **Reconstruct** and press <Enter> to reconstruct the logical drive.

 **NOTE:** After you start the reconstruct process, you must wait until it is complete. You cannot reboot, cancel, or exit until the reconstruction is complete.

Exiting the Configuration Utility

1. Press <Esc> when the **Management Menu** displays.
2. Select **Yes** at the prompt.
3. Reboot the system.

[Back to Contents Page](#)

Troubleshooting

Dell™ PowerEdge™ Expandable RAID Controller 4/SC, 4/DC, and 4e/DC User's Guide

- [General Problems](#)
- [BIOS Boot Error Messages](#)
- [Other Potential Problems](#)
- [Cache Migration](#)
- [SCSI Cable and Connector Problems](#)
- [Audible Warnings](#)

General Problems

[Table 6-1](#) describes general problems you might encounter, along with suggested solutions.

Table 6-1. General Problems

Problem	Suggested Solution
The system does not boot from the RAID controller.	<ol style="list-style-type: none"> 1 Check the system basic input/output system (BIOS) configuration for PCI interrupt assignments. Make sure a unique interrupt is assigned for the RAID controller. Initialize the logical drive before installing the operating system.
One of the hard drives in the array fails often.	<p>This could result from one or two problems.</p> <ol style="list-style-type: none"> 1 If the same drive fails: <ul style="list-style-type: none"> o Format the drive. o Check the enclosure or backplane for damage. o Check the SCSI cables. o Replace the hard drive. 1 Drives in the same slot keep failing: <p>Replace the cable or backplane, as applicable.</p>
After pressing <Ctrl><M> during bootup and trying to make a new configuration, the system hangs when scanning devices.	<ol style="list-style-type: none"> 1 Check the drives IDs on each channel to make sure each device has a different ID. 1 Check to make sure an internal connection and external connection are not occupying the same channel. 1 Check the termination. The device at the end of the channel must be terminated. 1 Check to make sure that the RAID controller is seated properly in the slot. 1 Replace the drive cable.
There is a problem spinning the drives all at once, when multiple drives are connected to the RAID controller using the same power supply.	<ol style="list-style-type: none"> 1 Set the drives to spin on command. This allows the RAID controller to spin two devices simultaneously.
Pressing <Ctrl><M> does not display a menu.	<ol style="list-style-type: none"> 1 These utilities require a color monitor.
At system power-up with the RAID controller installed, the BIOS banner display is garbled or does not appear at all.	<ol style="list-style-type: none"> 1 The RAID controller cache memory may be defective or missing.
Cannot flash or update the EEPROM.	<ol style="list-style-type: none"> 1 Contact Dell™ support for assistance. <p> NOTICE: Do not flash the firmware during a background initialization or data consistency check. Otherwise, the procedures will fail.</p>
Firmware Initializing... appears and remains on the screen.	<ol style="list-style-type: none"> 1 Make sure that TERMPWR is being properly provided to each peripheral device populated channel. 1 Make sure that each end of the SCSI channel chain is properly terminated using the recommended terminator type for the peripheral device. The channel is automatically terminated at the RAID controller if only one cable is connected to a channel. 1 Make sure that the RAID controller is properly seated in the PCI slot.
The BIOS Configuration Utility does not detect a replaced physical drive in a RAID 1 array and offer the option to start a rebuild.	<p>Perform the following steps to solve this problem:</p> <ol style="list-style-type: none"> 1 Access the BIOS Configuration Utility and select Objects—> Physical Drive to display the list of physical drives.

<p>After the drive is replaced, the utility shows all drives online and all logical drives reporting optimal state. It does not allow rebuild because no failed drives are found.</p> <p>This occurs if you replace the drive with a drive that contains data. If the new drive is blank, this problem does not occur.</p> <p>If you exit from this screen and restart the server, the system will not find the operating system.</p>	<ol style="list-style-type: none"> 1 Use the arrow key to select the newly inserted drive, then press <Enter>. <p>The menu for that drive displays.</p> <ol style="list-style-type: none"> 1 Select Force Offline and press <Enter>. <p>This changes the physical drive from Online to Failed.</p> <ol style="list-style-type: none"> 1 Select Rebuild and press <Enter>. <p>After rebuilding is complete, the problem is resolved and the operating system will boot.</p>
---	---

BIOS Boot Error Messages

[Table 6-2](#) describes error messages about the BIOS that can display at bootup, the problems, and suggested solutions.

Table 6-2. BIOS Boot Error Messages

Message	Problem	Suggested Solution
Adapter BIOS Disabled. No Logical Drives Handled by BIOS	The BIOS is disabled. Sometimes the BIOS is disabled to prevent booting from the BIOS. This is the default when cluster mode is enabled.	<ol style="list-style-type: none"> 1 Enable the BIOS by pressing <Ctrl><M> at the boot prompt to run the BIOS Configuration Utility.
Host Adapter at Baseport xxxx Not Responding	The BIOS cannot communicate with the adapter firmware.	<ol style="list-style-type: none"> 1 Make sure the RAID controller is properly installed. 1 Check SCSI termination and cables.
No PERC 4 Adapter	The BIOS cannot communicate with the adapter firmware.	<ol style="list-style-type: none"> 1 Make sure the RAID controller is properly installed.
Run View/Add Configuration option of Configuration Utility. Press A Key to Run Configuration Utility Or <Alt><F10> to Continue.	The configuration data stored on the RAID controller does not match the configuration data stored on the drives.	<ol style="list-style-type: none"> 1 Press <Ctrl><M> to run the BIOS Configuration Utility. 1 Select Configure → View/Add Configuration to examine both the configuration data in non-volatile random access memory (NVRAM) and the configuration data stored on the hard drives. 1 Resolve the problem by selecting one of the configurations. 1 If you press <Alt><F10> to continue, the configuration data on the NVRAM will be used to resolve the mismatch.
Unresolved configuration mismatch between disks and NVRAM on the adapter after creating a new configuration	Some legacy configurations in the drives cannot be cleared.	<ol style="list-style-type: none"> 1 Clear the configuration. 1 Clear the related drives and re-create the configuration.
1 Logical Drive Failed	A logical drive failed to sign on.	<ol style="list-style-type: none"> 1 Make sure all physical drives are properly connected and are powered on. 1 Run the BIOS Configuration Utility to find out whether any physical drives are not responding. 1 Reconnect, replace, or rebuild any drive that is not responding.
X Logical Drives Degraded	X number of logical drives signed on in a degraded state.	<ol style="list-style-type: none"> 1 Make sure all physical drives are properly connected and are powered on. 1 Run the BIOS Configuration Utility to find whether any physical drives are not responding. 1 Reconnect, replace, or rebuild a drive that is not responding.
Insufficient memory to run BIOS Press any key to continue...	Not enough memory to run the BIOS	<ol style="list-style-type: none"> 1 Make sure the cache memory has been properly installed.
Insufficient Memory	Not enough memory on the adapter to support the current configuration.	<ol style="list-style-type: none"> 1 Make sure the cache memory has been properly installed.

The following SCSI IDs are not responding: Channel x:a.b.c	The physical drives with SCSI IDs a, b, and c are not responding on SCSI channel x.	1. Make sure the physical drives are properly connected and are powered on.
Following SCSI disk not found and no empty slot available for mapping it	The physical disk roaming feature did not find the physical disk with the displayed SCSI ID. No slot is available to map the physical drive and the RAID controller cannot resolve the physical drives into the current configuration.	1. Reconfigure the array.
Following SCSI IDs have the same data y, z Channel x: a, b, c	The physical drive roaming feature found the same data on two or more physical drives on channel x with SCSI IDs a, b, and c. The RAID controller cannot determine the drive that has the duplicate information.	1. Remove the drive or drives that should not be used.
Unresolved configuration mismatch between disks and NVRAM on the adapter	The RAID controller is unable to determine the proper configuration after reading both NVRAM and Configuration on Disk	1. Press <Ctrl><M> to run the BIOS Configuration Utility. 1. Select Configure—> New Configuration to create a new configuration. Note that this will delete any configuration that existed.

Other Potential Problems

[Table 6-3](#) describes other problems that can occur.

Table 6-3. Other Potential Problems

Topic	Information
Physical drive errors	To display the BIOS Configuration Utility Media Error and Other Error options, press <F2> after selecting a physical drive under the Objects—> Physical Drive menu. A Media Error is an error that occurs while transferring data. An Other Error is an error that occurs at the hardware level, such as a device failure, poor cabling, bad termination, or signal loss.
RAID controller power requirements	The maximum power requirements are 15 watts at 5-V and 3 Amps.
Changes in the BIOS Configuration Utility do not appear to take affect.	When there are multiple controllers in a system, make sure the correct controller is selected in the BIOS Configuration Utility.

Cache Migration

To move cache memory from one controller to another, first determine whether the cache memory contains data, then transfer it to the other controller. The cache memory with a transportable battery backup unit (TBBU) contains an LED that lights up if data exists on the cache memory.

If the cache memory contains data, perform the following steps before you move the cache from one controller to another:

1. Make sure the NVRAM configuration on the new controller is cleared.
 - a. Before connecting any disks to the new controller, start the system and press <Ctrl><M> at the prompt to enter the BIOS Configuration Utility.
 - b. If there is an existing configuration on the new controller, **make sure that no drives are connected to the new controller before clearing the NVRAM configuration.**
 - c. Access the Management Menu, then select **Configure—> Clear Configuration**.

This clears the configuration on the NVRAM.

2. Make sure that the configuration data on the disks is intact.

3. Transfer the cache to the new controller and connect the drives in the same order as they were connected on the previous adapter.

This ensures that the configuration data on the cache matches the configuration data on they physical disks. This is important for successful cache migration.

4. Power on the system.
-

SCSI Cable and Connector Problems

If you are having problems with your SCSI cables or connectors, first check the cable connections. If still having a problem, visit the Dell's website at www.dell.com for information about qualified small computer system interface (SCSI) cables and connectors or contact your Dell representative for information.

Audible Warnings

The RAID controller has a speaker that generates warnings to indicate events and errors. [Table 6-4](#) describes the warnings.

Table 6-4. Audible Warnings

Tone Pattern	Meaning	Examples
Three seconds on and one second off	A logical drive is offline.	One or more drives in a RAID 0 configuration failed. Two or more drives in a RAID 1 or 5 configuration failed.
One second on and one second off	A logical drive is running in degraded mode.	One drive in a RAID 5 configuration failed.
One second on and three seconds off	An automatically initiated rebuild has been completed.	While you were away from the system, a hard drive in a RAID 1 or 5 configuration failed and was rebuilt.

[Back to Contents Page](#)

[Back to Contents Page](#)

Appendix A: Regulatory Notice

Dell™ PowerEdge™ Expandable RAID Controller 4/SC, 4/DC, and 4e/DC User's Guide

- [FCC Notices \(U.S. Only\)](#)
 - [A Notice About Shielded Cables](#)
 - [Class B](#)
 - [Canadian Compliance \(Industry Canada\)](#)
 - [MIC Notice \(Republic of Korea Only\)](#)
 - [VCCI Class B Statement](#)
-

FCC Notices (U.S. Only)

Most Dell systems are classified by the Federal Communications Commission (FCC) as Class B digital devices. However, the inclusion of certain options changes the rating of some configurations to Class A. To determine which classification applies to your system, examine all FCC registration labels located on the back panel of your system, on card-mounting brackets, and on the controllers -themselves. If any one of the labels carries a Class A rating, your entire system is considered to be a Class A digital device. If all labels carry either the Class B rating or the FCC logo (FCC), your system is considered to be a Class B digital device.

Once you have determined your system's FCC classification, read the appropriate FCC notice. Note that FCC regulations provide that changes or modifications not expressly approved by Dell Inc. could void your authority to operate this equipment.

A Notice About Shielded Cables

Use only shielded cables for connecting peripherals to any Dell device to reduce the possibility of interference with radio and television reception. Using shielded cables ensures that you maintain the appropriate FCC radio frequency emissions compliance (for a Class A device) or FCC certification (for a Class B device) of this product. For parallel printers, a cable is available from Dell Inc.

Class B

This equipment generates, uses, and can radiate radio frequency energy and, if not installed and used in accordance with the manufacturer's instruction manual, may cause interference with radio and television reception. This equipment has been tested and found to comply with the limits for a Class B digital device pursuant to Part 15 of the FCC Rules. These limits are designed to provide reasonable protection against harmful interference in a residential installation.

However, there is no guarantee that interference will not occur in a particular installation. If this equipment does cause harmful interference with radio or television reception, which can be determined by turning the equipment off and on, you are encouraged to try to correct the interference by one or more of the following measures:

- 1 Reorient the receiving antenna.
- 1 Relocate the system with respect to the receiver.
- 1 Move the system away from the receiver.
- 1 Plug the system into a different outlet so that the system and the receiver are on different branch circuits.

If necessary, consult a representative of Dell Inc. or an experienced radio/television technician for additional suggestions. You may find the following booklet helpful: FCC Interference Handbook, 1986, available from the U.S. Government Printing Office, Washington, DC 20402, Stock No. 004-000-00450-7. This device complies with Part 15 of the FCC Rules. Operation is subject to the following two conditions:

- 1 This device may not cause harmful interference.
- 1 This device must accept any interference received, including interference that may cause undesired operation.

The following information is provided on the device or devices covered in this document in compliance with FCC regulations:

1 Product name: Dell PowerEdge Expandable RAID Controller 4 Controller

1 Company name:

Dell Inc.
Regulatory Department
One Dell Way
Round Rock, Texas 78682 USA
512-338-4400

Canadian Compliance (Industry Canada)

Canadian Regulatory Information (Canada Only)

This digital apparatus does not exceed the Class B limits for radio noise emissions from digital apparatus set out in the Radio Interference Regulations of the Canadian Department of Communications. Note that the Canadian Department of Communications (DOC) regulations provide, that changes or modifications not expressly approved by Intel could void your authority to operate the equipment. This Class B digital apparatus meets all the requirements of the Canadian Interference -Causing Equipment Regulations.

Cet appareil numerique de la classe B respecte toutes les exigences du Reglement sur la material brouilleur du Canada.

MIC Notice (Republic of Korea Only)

B Class Device

기준별	사용자 안내문
B급 기기 (가정용 정보통신기기)	이 기기는 가정용으로 전자파적합등록을 한 기기로서 주거지역에서는 물론 모든 지역에서 사용할 수 있습니다.

Please note that this device has been approved for non-business purposes and may be used in any environment, including residential areas.



기 기 의 명 칭 PCI-E Host Adapter
 기 기 의 규 모 번 호 D1037
 성 명 또는 상 호 LSI LOGIC CORPORATION
 제 조 자 및 제 조 국 가 SCI SYSTEMS(THAILAND) LTD./미국
 인 승 년 월 일 2004년(Year) 08월(Month) 19일(Date)



기 기 의 명 칭 PCI Host Adapter
 기 기 의 보 호 번 호 SERIES 619 and 620
 성 명 또는 상 호 LSI LOGIC CORPORATION
 제 조 자 및 제 조 국 가 SCI SYSTEMS(THAILAND) LTD./미국
 인 승 년 월 일 2004년(Year) 08월(Month) 19일(Date)

VCCI Class B Statement

この装置は、情報処理装置等電波障害自主規制協議会（VCCI）の基準に基づくクラスB情報技術装置です。この装置は、家庭環境で使用することを目的としていますが、この装置がラジオやテレビジョン受信機に近接して使用されると、受信障害を引き起こすことがあります。
取扱説明書に従って正しい取り扱いをして下さい。

[Back to Contents Page](#)

[Back to Contents Page](#)

Overview

Dell™ PowerEdge™ Expandable RAID Controller 4/SC and 4/DC User's Guide

- [Overview of PERC 4/SC and 4/DC](#)
 - [Documentation](#)
-

Overview of PERC 4/SC and 4/DC

The PERC 4 RAID controller is a high-performance, intelligent peripheral component interconnect (PCI)-to-small computer system interface (SCSI) host adapter with RAID control capabilities. It provides reliability, high performance, fault-tolerant disk subsystem management, and is an ideal RAID solution for internal storage in Dell's workgroup, departmental, and enterprise systems. The RAID controller offers a cost-effective way to implement RAID in a server.

PERC 4 controllers are available with one or two SCSI channels:

- 1 PERC 4/SC (single channel) provides one SCSI channel.
- 1 PERC 4/DC (dual channel) provides two SCSI channels.

Your RAID controller supports a low-voltage differential (LVD) SCSI bus. Using LVD, you can use cables up to 12 meters long. Throughput on each SCSI channel can be as high as 320 MB/sec.

Documentation

The technical documentation set includes:

- 1 *PERC 4 RAID Controller User's Guide*
- 1 *CERC and PERC RAID Controllers Operating System Driver Installation Guide*

PERC 4 RAID Controller User's Guide

The *PERC 4 RAID Controller User's Guide* contains information about installation of the RAID controller, general introductory information about RAID, RAID system planning, configuration information, and software utility programs.

CERC and PERC RAID Controllers Operating System Driver Installation Guide

This manual provides all the information you need to install the appropriate operating system software drivers.

[Back to Contents Page](#)

[Back to Contents Page](#)

RAID Controller Features

Dell™ PowerEdge™ Expandable RAID Controller 4/SC and 4/DC User's Guide

- [Hardware Requirements](#)
- [RAID Controller Specifications](#)
- [Configuration Features](#)
- [Hardware Architecture Features](#)
- [Array Performance Features](#)
- [Fault Tolerance Features](#)
- [Software Utilities](#)
- [Operating System Software Drivers](#)
- [RAID Management Utilities](#)

Hardware Requirements

The RAID controller can be installed in a Dell™ PowerEdge™ system with a motherboard that has 5-V or 3.3-V, 32- or 64-bit PCI slots.

 **NOTE:** PERC 4/DC supports clustering, but PERC 4/SC does not.

RAID Controller Specifications

[Table 2-1](#) provides a summary of the specifications for the RAID controller.

Table 2-1. RAID Controller Specifications

Parameters	PERC 4/SC Specifications	PERC 4/DC Specifications
Card size	Low-profile PCI adapter card size (6.875" X 4.2")	Half-length PCI adapter card size (6.875" X 4.2")
Processor	Intel® GC80302 (Zion Lite)	Intel GC80303 (Zion)
Bus type	PCI 2.2	PCI 2.2
PCI bus data transfer rate	Up to 532 MB/sec	Up to 532 MB/sec
Cache configuration	64 MB SDRAM	128 MB SDRAM
Firmware	Flash size is 1MB.	Flash size is 1MB.
Nonvolatile random access memory (RAM)	32 KB for storing RAID configuration	32 KB for storing RAID configuration
Operating voltage and tolerances	3.3V +/- 0.3V, 5V +/- 5%, +12V +/- 5%, -12V +/- 10%	3.3V +/- 0.3V, 5V +/- 5%, +12V +/- 5%, -12V +/- 10%
SCSI controller	One SCSI LSI53C1020 controller for Ultra320 support	One SCSI LSI53C1030 controller for Ultra320 support
SCSI data transfer rate	Up to 320 MB/sec per channel	Up to 320 MB/sec per channel
SCSI bus	LVD, Single-ended (SE)	LVD, Single-ended (SE)
SCSI termination	Active	Active
Termination disable	Automatic through cable and device detection	Automatic through cable and device detection This is automatic capable, but jumpers by default do not allow auto termination on PERC 4/DC.
Devices per SCSI channel	Up to 15 Wide SCSI devices	Up to 15 Wide SCSI devices
SCSI device types	Synchronous or asynchronous	Synchronous or asynchronous
RAID levels supported	0, 1, 5, 10, 50	0, 1, 5, 10, 50
SCSI connectors	One 68-pin internal high-density connector for SCSI devices. One very high density 68-pin external connector for Ultra320 and Wide SCSI.	Two 68-pin internal high-density connectors for SCSI devices. Two very high density 68-pin external connectors for Ultra320 and Wide SCSI.
Serial port	3-pin RS232C-compatible connector (for manufacturing use only)	3-pin RS232C-compatible connector (for manufacturing use only)

Cache Memory

64 MB of cache memory resides in a memory bank for PERC 4/SC and 128 MB for PERC 4/DC. The RAID controller supports write-through or write-back caching, selectable for each logical drive. To improve performance in sequential disk accesses, the RAID controller uses read-ahead caching by default. You can disable read-ahead caching.

Onboard Speaker

The RAID controller has a speaker that generates audible warnings when system errors occur. No management software needs to be loaded for the speaker to work.

Alarm Beep Codes

The purpose of the alarm is to indicate changes which require attention. The following conditions trigger the alarm to sound:

- 1 A logical drive is offline.
- 1 A logical drive is running in degraded mode.
- 1 An automatic rebuild has been completed.
- 1 The temperature is above or below the acceptable range.
- 1 The firmware gets a command to test the speaker from an application.

Each of the conditions has a different beep code, as shown in [Table 2-2](#). Every second the beep switches on or off per the pattern in the code. For example, if the logical drive goes offline, the beep code is three one-second beeps followed by one second of silence.

Table 2-2. Alarm Beep Codes

Alarm Description	Code
A logical drive is offline.	Three seconds on, one second off
A logical drive is running in degraded mode.	One second on, one second off
An automatic rebuild has been completed.	One second on, three seconds off
The temperature is above or below the acceptable range.	Two seconds on, two seconds off
The firmware gets a command to test the speaker from an application.	Four seconds on

BIOS

For easy upgrade, the BIOS resides on 1 MB flash memory. It provides an extensive setup utility that you can access by pressing <Ctrl><M> at BIOS initialization to run the BIOS Configuration Utility.

Background Initialization

Background initialization is the automatic check for media errors on physical drives. It makes sure that striped data segments are the same on all physical drives in an array.



NOTE: Unlike initialization of logical drives, background initialization does not clear data from the drives. The background initialization rate is controlled by the rebuild rate set using the BIOS Configuration Utility, <Ctrl><M>. The default and recommended rate is 30%. You must stop the background initialization before you change the rebuild rate or the rate change will not affect the background initialization rate. After you stop background initialization and change the rebuild rate, the rate change takes affect when you restart background initialization.

Configuration Features

[Table 2-3](#) lists the configuration features for the RAID controller.

Table 2-3. Configuration Features

Specifications	PERC 4/SC	PERC 4/DC
RAID levels	0, 1, 5, 10, and 50	0, 1, 5, 10, and 50
SCSI channels	1	2
Maximum number of drives per channel	14	14 (for a maximum of 28 on two channels)
Array interface to host	PCI Rev 2.2	PCI Rev 2.2
Cache memory size	64 MB SDRAM	Up to 128 MB SDRAM
Cache Function	Write-back, write-through, adaptive read-ahead, non read-ahead, read-ahead	Write-back, write-through, adaptive read-ahead, non read-ahead, read-ahead
Number of logical drives and arrays supported	Up to 40 logical drives and 32 arrays per controller	Up to 40 logical drives and 32 arrays per controller
Hot spares	Yes	Yes
Flashable firmware	Yes	Yes
Hot swap devices supported	Yes	Yes
Non-disk devices supported	Only SAF-TE and SES	Only SAF-TE and SES
Mixed capacity hard drives	Yes	Yes
Number of 16-bit internal connectors	1	2
Cluster support	No	Yes

Firmware Upgrade

You can download the latest firmware from the Dell web site and flash it to the firmware on the board. Perform the following steps to upgrade the firmware:

1. Go to the support.dell.com web site.
2. Download the latest firmware and driver to a diskette.

The firmware is an executable file that downloads the files to the diskette in your system.

3. Restart the system and boot from the diskette.
4. Run `pf1ash` to flash the firmware.

 **CAUTION:** Do not flash the firmware while performing a background initialization or data consistency check, as it can cause the procedures to fail.

SMART Hard Drive Technology

The Self-Monitoring Analysis and Reporting Technology (SMART) detects predictable hard drive failures. SMART monitors the internal performance of all motors, heads, and hard drive electronics.

Drive Roaming

Drive roaming (also known as configuration on disk) occurs when the hard drives are changed to different channels on the same controller. When the drives are placed on different channels, the controller detects the RAID configuration from the configuration information on the drives.

Configuration data is saved in both non-volatile random access memory (NVRAM) on the RAID controller and on the hard drives attached to the controller. This maintains the integrity of the data on each drive, even if the drives have changed their target ID. Drive roaming is supported across channels on the same controller, except when cluster mode is enabled.

 **NOTE:** Drive roaming does not work if you move the drives to a new controller and put them on different channels on the new adapter. If you put drives on a new controller, they must be on the same channel/target as they were on the previous controller to keep the same configuration.

 **NOTE:** Before performing drive roaming, make sure that you have first powered off both your platform and your drive enclosure.

[Table 2-4](#) lists the drive roaming features for the RAID controller.

Table 2-4. Features for Drive Roaming

Specification	PERC 4/SC	PERC 4/DC
Online RAID level migration	Yes	Yes
RAID remapping	Yes	Yes
No reboot necessary after capacity extension	Yes	Yes

Drive Migration

Drive migration is the transfer of a set of hard drives in an existing configuration from one controller to another. The drives must remain on the same channel and be reinstalled in the same order as in the original configuration.

 **NOTE:** Drive roaming and drive migration cannot be supported at the same time. PERC can support either drive roaming or drive migration at any one time, but not both at the same time.

Hardware Architecture Features

[Table 2-5](#) displays the hardware architecture features for the RAID controller.

Table 2-5. Hardware Architecture Features

Specification	PERC 4/SC	PERC 4/DC
Processor	Intel GC80302 (Zion Lite)	Intel GC80303 (Zion)
SCSI controller(s)	One LSI53C1020 Single SCSI controller	One LSI53C1030 Dual SCSI controller
Size of flash memory	1 MB	1 MB
Amount of NVRAM	32 KB	32 KB
Hardware exclusive OR (XOR) assistance	Yes	Yes
Direct I/O	Yes	Yes
SCSI bus termination	Active or LVD	Active or LVD
Double-sided dual inline memory modules (DIMMs)	Yes	Yes
Support for hard drives with capacities of more than eight gigabytes (GB)	Yes	Yes
Hardware clustering support on the controller	No	Yes

LED Operation

The LED on the system displays the data for a PV Dell enclosure connected a PERC 4/DC RAID controller. [Table 2-6](#) displays the normal operation mode after you remove a physical drive and place it back in the slot.

Table 2-6. LED Operation

Controller/ System	Physical Drive State	Virtual Disk State	Physical Drive State	Virtual Disk State	Status LED Blink Pattern
PV Dell enclosure attached to PERC 4/DC online	Online	Ready	Rebuilding	Degraded	Only reinserted disk blinks during rebuild

Array Performance Features

[Table 2-7](#) displays the array performance features for the RAID controller.

Table 2-7. Array Performance Features

Specification	PERC 4/SC and PERC 4/DC
PCI host data transfer rate	532 MB/sec
Drive data transfer rate	Up to 320 MB/sec
Maximum size of I/O requests	6.4 MB in 64 KB stripes
Maximum queue tags per drive	As many as the drive can accept
Stripe sizes	2 KB, 4 KB, 8 KB, 16 KB, 32 KB, 64 KB, or 128 KB  NOTE: Using a 2 KB or 4 KB stripe size is not recommended.
Maximum number of concurrent commands	255
Support for multiple initiators	Only on PERC 4/DC

Fault Tolerance Features

[Table 2-8](#) describes the fault tolerance capabilities of the RAID controller.

Table 2-8. Fault Tolerance Features

Specification	PERC 4/SC	PERC 4/DC
Support for SMART	Yes	Yes
Optional battery backup for cache memory	N/A	Yes. Up to 72 hours data retention for 64 MB cache memory (less for larger cache memory).
Drive failure detection	Automatic	Automatic
Drive rebuild using hot spares	Automatic	Automatic
Parity generation and checking	Yes	Yes
User-specified rebuild rate	Yes	Yes

Software Utilities

[Table 2-9](#) describes the features offered by the utilities used for RAID management. See "[RAID Management Utilities](#)" in this section for descriptions of the utilities.

Table 2-9. Software Utilities Features

Specification	PERC 4/SC	PERC 4/DC
Management utility	Yes	Yes
Bootup configuration using the PERC BIOS Configuration Utility (Ctrl-M)	Yes	Yes
Online read, write, and cache policy switching	Yes	Yes

Operating System Software Drivers

Operating System Drivers

Drivers are provided to support the controller on the following operating systems:

- 1 Microsoft® Windows NT®
- 1 Windows® 2000
- 1 Windows 2003
- 1 Novell® NetWare®

See the *CERC and PERC RAID Controllers Operating System Driver Installation Guide* for more information about the drivers.

SCSI Firmware

The RAID controller firmware handles all RAID and SCSI command processing and supports the features described in [Table 2-10](#).

Table 2-10. SCSI Firmware Support

Feature	PERC 4/SC and PERC 4/DC Description
Disconnect/reconnect	Optimizes SCSI bus utilization
Tagged command queuing	Multiple tags to improve random access
Multi-threading	Up to 255 simultaneous commands with elevator sorting and concatenation of requests per SCSI channel
Stripe size	Variable for all logical drives: 2 KB, 4 KB, 8 KB, 16 KB, 32 KB, 64 KB, or 128 KB.  NOTE: Using a 2 KB or 4 KB stripe size is not recommended.
Rebuild	Multiple rebuilds and consistency checks with user-definable priority.

RAID Management Utilities

Software utilities enable you to manage and configure the RAID system, create and manage multiple disk arrays, control and monitor multiple RAID servers, provide error statistics logging, and provide online maintenance. The utilities include:

- 1 BIOS Configuration Utility
- 1 Dell Manager for Linux
- 1 Dell OpenManage™ Array Manager for Windows and Netware

BIOS Configuration Utility

The BIOS Configuration Utility configures and maintains RAID arrays, clears hard drives, and manages the RAID system. It is independent of any operating system. See "[BIOS Configuration Utility and Dell Manager](#)" for additional information.

Dell Manager

Dell Manager is a utility that works in Red Hat Linux. See "[BIOS Configuration Utility and Dell Manager](#)" for additional information.

Dell OpenManage Array Manager

Dell OpenManage Array Manager is used to configure and manage a storage system that is connected to a server, while the server is active and continues to handle requests. Array Manager runs under Novell NetWare, Windows NT, and Windows 2000. Refer to Dell documentation and CDs at the Dell Support web site at support.dell.com for more information.

 **NOTE:** You can run the OpenManage Array Manager remotely to access NetWare, but not locally.

[Back to Contents Page](#)

Hardware Installation

Dell™ PowerEdge™ Expandable RAID Controller 4/SC and 4/DC User's Guide

- [Requirements](#)
 - [Quick Installation Procedure](#)
 - [Installation Steps](#)
-

Requirements

This section describes the procedures for installing the RAID controller. You must have the following items to install the controller:

- 1 A PERC 4/SC or 4/DC controller
 - 1 A host system with an available 32- or 64-bit, 3.3-V PCI extension slot
 - 1 The *Dell OpenManage™ Systems Management* CD or driver diskette
 - 1 The necessary internal and/or external SCSI cables
 - 1 Ultra, Ultra2, Ultra3, Ultra160, or Ultra320 SCSI hard drives (SCSI is backward compatible, but it slows to the speed of the slowest device).
-

Quick Installation Procedure

Perform the following steps for quick installation of the controller if you are an *experienced system user/installer*. All others should follow the steps in the next section, [Installation Steps](#).

1. Turn off all power to the server and all hard drives, enclosures, and system components.
 2. Open host system by following the instructions in the host system technical documentation.
 3. Determine the SCSI ID and SCSI termination requirements.
 4. Install the RAID controller in the server and attach the SCSI cables and terminators.
 - 1 Make sure pin 1 on the cable matches pin 1 on the connector.
 - 1 Make sure that the SCSI cables conform to all SCSI specifications.
 5. Perform a safety check.
 - 1 Make sure all cables are properly attached.
 - 1 Make sure the RAID controller is properly installed.
 - 1 Close the cabinet of the host system.
 - 1 Turn power on after completing the safety check.
 6. Format the hard drives as needed.
 7. Configure logical drives using the BIOS Configuration Utility or Dell Manager.
 8. Initialize the logical drives.
 9. Install the network operating system drivers as needed.
-

Installation Steps

This section provides instructions for installing the RAID controllers.

Step 1 Unpack the Controller

NOTICE: See the safety instructions in your system documentation for information about protecting against electrostatic discharge.

Unpack and remove the controller and inspect it for damage. If the controller appears damaged, or if any items listed below are missing, contact your Dell support representative. The RAID controller is shipped with:

- 1 The *PERC 4 RAID Controller User's Guide* (on CD)
- 1 The *CERC and PERC RAID Controllers Operating System Driver Installation Guide* (on CD)

NOTE: You can order a hard copy of the documentation for the controller.

- 1 A license agreement

Step 2 Power Down the System

Perform the following steps to power down the system:

- 1. Turn off the system.
- 2. Remove the AC power cord.
- 3. Disconnect the system from any networks before installing the controller.
- 4. Remove the system's cover.

Please consult the system documentation for instructions.

Step 3 Set Jumpers

Make sure the jumper settings on the RAID controller are correct. Following are diagrams of the controllers showing their jumpers and connectors, and tables describing them. Select your controller from the ones shown on the following pages.

PERC 4/SC Jumpers and Connectors

Figure 3-1. PERC 4/SC Controller Layout

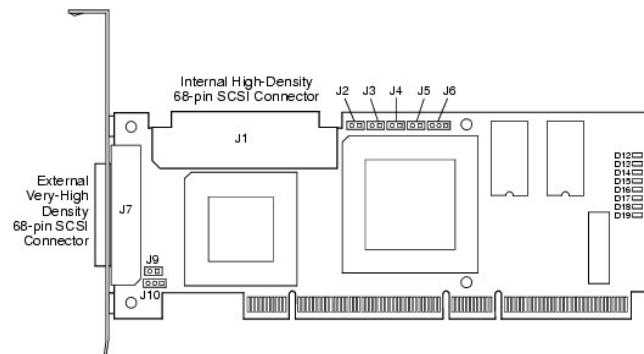

Table 3-1. PERC 4/SC Jumper and Connector Descriptions

Connector	Description	Type	Setting
J1	Internal SCSI connector	68-pin connector	Internal high-density SCSI bus connector. Connection is optional.
J2	NVRAM Clear	2-pin header	To CLEAR configuration data, install a jumper.
J3	Serial EPROM	2-pin header	To CLEAR configuration data, install a jumper.
J4	Onboard BIOS Enable	2-pin header	No jumper = Enabled (Default is Enabled)

			With jumper in = Disabled
J5	SCSI Activity	2-pin header	Connector for enclosure LED to indicate data transfers. Connection is optional.
J6	Serial Port	3-pin header	Connector is for diagnostic purposes. Pin-1 RXD (Receive Data) Pin-2 TXD (Transmit Data) Pin-3 GND (Ground)
J7	External SCSI connector	68-pin connector	External very-high density SCSI bus connector. Connection is optional.
J9	SCSI bus TERMPWR Enable	2-pin header	Install jumper to enable onboard termination power. Default is installed.
J10	SCSI bus Termination Enable	3-pin header	Jumper pins 1-2 to enable software control of SCSI termination through drive detection. Jumper pins 2-3 to disable onboard SCSI termination. Having no jumper installed enables onboard SCSI termination. The default is no jumper installed.
D12 - D19	LEDs		Indicate problems with the card.

PERC 4/DC Jumpers and Connectors

Figure 3-2. PERC 4/DC Controller Layout

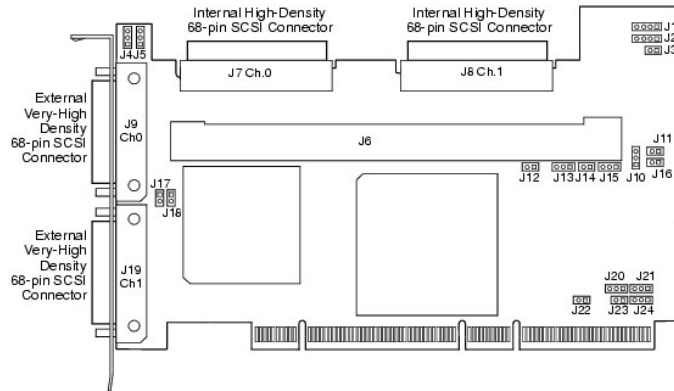

Table 3-2. PERC 4/DC Jumper and Connector Descriptions

Connector	Description	Type	Settings
J1	I2C Header	4-pin header	Reserved.
J2	SCSI Activity LED	4-pin header	Connector for LED on enclosure to indicate data transfers. Optional.
J3	Write Pending Indicator (Dirty Cache LED)	2-pin header	Connector for enclosure LED to indicate when data in the cache has yet to be written to the device. Optional.
J4	SCSI Termination Enable Channel 1	3-pin header	Jumper pins 1-2 to enable software control of SCSI termination via drive detection. Jumper pins 2-3 to disable onboard SCSI termination.
J5	SCSI Termination Enable Channel 0	3-pin header	No Jumper installed enables onboard SCSI termination. (See J17 and J18). The default is no jumper installed.
J6	DIMM socket	DIMM socket	Socket that hold the memory module
J7	Internal SCSI Channel 0 connector	68-pin connector	Internal high-density SCSI bus connector. Connection is optional.
J8	Internal SCSI Channel 1 connector	68-pin connector	
J9	External SCSI Channel 0 connector	68-pin connector	External very-high density SCSI bus connector. Connection is optional.
J10	Battery connector	3-pin header	Connector for an optional battery pack. Pin-1 -BATT Terminal (black wire) Pin-2 Thermistor (white wire) Pin-3 +BATT Terminal (red wire)
J11	NVRAM clear	2-pin header	To CLEAR the configuration data, install a jumper.
J12	NMI jumper	2-pin header	Reserved for factory.
J13	32-bit SPCI Enable	3-pin header	Reserved for factory.
J14	Mode Select Jumper	2-pin header	
J15	Serial Port	3-pin header	Connector is for diagnostic purposes. Pin-1 RXD (Receive Data)

			Pin-2 TXD (Transmit Data) Pin-3 GND (Ground)
J16	Onboard BIOS Enable	2-pin header	No jumper = Enabled (Default setting) Jumpered = Disabled
J17	TERMPWR Enable Channel 0	2-pin header	Jumper installed enables TERMPWR from the PCI bus. Default setting.
J18	TERMPWR Enable Channel 1	2-pin header	No jumper installed enables TERMPWR from the SCSI bus. (See J4 and J5)
J19	External SCSI Channel 1	68-pin connector	External very-high density SCSI bus connector. Connection is optional.
J23	Serial EEPROM	2-pin header	To CLEAR configuration data, install a jumper.
D17 - D24	LED (located on back of card)		Indicate problems with the card.

Step 4 Install the RAID Controller

Perform the following steps to install the controller:

1. Select a 3.3-V PCI slot and align the controller PCI bus connector to the slot.
2. Press down gently but firmly to make sure that the controller is properly seated in the slot, as shown in [Figure 3-3](#).
3. Screw the bracket to the system chassis.

Figure 3-3. Inserting the RAID Controller into a PCI Slot

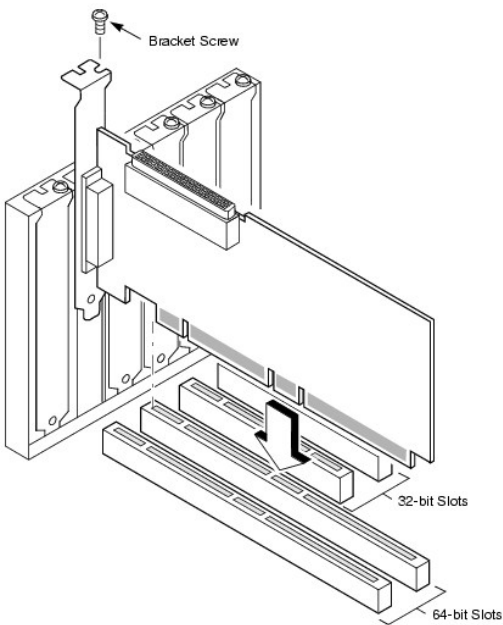

Step 5 Connect SCSI Cables and SCSI Devices

Connect the SCSI cables to the SCSI connectors and SCSI devices.

Connect SCSI Devices

Perform the following steps to connect SCSI devices.

1. Disable termination on any SCSI device that does *not* sit at the end of the SCSI bus.
2. Configure all SCSI devices to supply TermPWR..
3. Set proper target IDs (TIDs) for all SCSI devices.

4. The host controller has a SCSI ID of 7.
5. Connect the cable to the devices.

 **NOTE:** The maximum cable length for Fast SCSI (10 MB/sec) devices is 3 meters and for Ultra SCSI devices is 1.5 meters. The cable length can be up to 12 meters for LVD devices. Use shorter cables if possible.

Cable Suggestions

System throughput problems can occur if the SCSI cables are not the correct type. To avoid problems, you should follow the following cable suggestions:

- 1 Use cables no longer than 12 meters for Ultra3, Ultra160, and Ultra320 devices. (It's better to use shorter cables if possible.)
- 1 Make sure the cables meet the specifications.
- 1 Use active termination.
- 1 **Note that cable stub length should be no more than 0.1 meter (4 inches).**
- 1 Route SCSI cables carefully and do not bend cables.
- 1 Use high impedance cables.
- 1 Do not mix cable types (choose either flat or rounded and shielded or non-shielded).
- 1 Note that ribbon cables have fairly good cross-talk rejection characteristics, meaning the signals on the different wires are less likely to interfere with each other.

Step 6 Set Target IDs

Set target identifiers (TIDs) on the SCSI devices. Each device in a channel must have a unique TID. Non-disk devices should have unique SCSI IDs *regardless of the channel where they are connected*. See the documentation for each SCSI device to set the TIDs. The RAID controller automatically occupies TID 7, which is the highest priority. The arbitration priority for a SCSI device depends on its TID. [Table 3-3](#) lists the target IDs.

Table 3-3. Target IDs

Priority	Highest											Lowest
TID	7	6	5	...	2	1	0	15	14	...	9	8

Step 7 Set SCSI Termination

The SCSI bus is an electrical transmission line and must be terminated properly to minimize reflections and losses. Termination should be set at each end of the SCSI cable(s).

For a disk array, set SCSI bus termination so that removing or adding a SCSI device does not disturb termination. An easy way to do this is to connect the RAID controller to one end of the SCSI cable and an external terminator module at the other end of the cable, as shown in [Figure 3-4](#).

The connectors between the two ends can connect SCSI drives which have their termination disabled, as shown in the drives (ID0, ID1, ID2) attached in the figure. See the manual for each SCSI drive to disable termination.

Set the termination so that SCSI termination and TermPWR are intact when any hard drive is removed from a SCSI channel.

Figure 3-4. Terminating Internal SCSI Disk Array

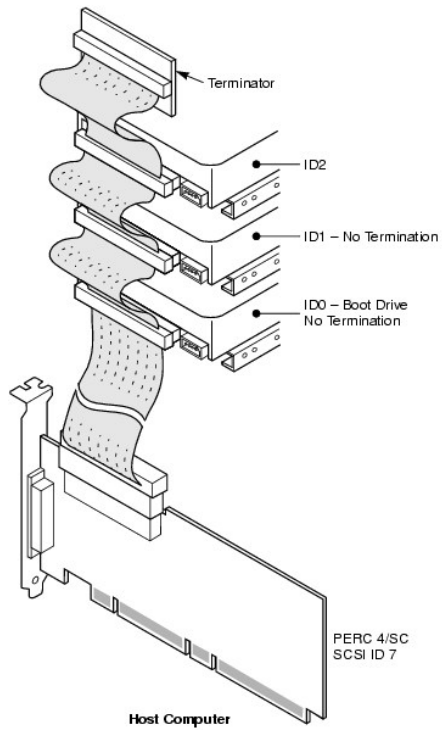

Step 8 Start the System

Replace the system cover and reconnect the AC power cords. Turn power on to the host system. Set up the power supplies so that the SCSI devices are powered up at the same time as or before the host system. If the system is powered up before a SCSI device, the device might not be recognized.

During bootup, the BIOS message appears:

```
PowerEdge Expandable RAID Controller BIOS Version x.xx date
```

```
Copyright (c) Dell Inc
```

```
Firmware Initializing... [ Scanning SCSI Device ...(etc.)... ]
```

The firmware takes several seconds to initialize. During this time the adapter scans the SCSI channel. When ready, the following appears:

```
HA -0 (Bus 1 Dev 6) Type: PERC 4/xx Standard FW x.xx SDRAM=xxxMB
```

```
0 Logical Drives found on the Host Adapter
```

```
0 Logical Drive(s) handled by BIOS
```

```
Press <Ctrl><M> to run PERC 4 BIOS Configuration Utility
```

The BIOS Configuration Utility prompt times out after several seconds.

The host controller number, firmware version, and cache SDRAM size display in the second portion of the BIOS message. The numbering of the controllers follows the PCI slot scanning order used by the host motherboard.

Light-emitting Diode (LED) Description

When you start the system, the boot block and firmware perform a number of steps that load the operating system and allow the system to function properly. The boot block contains the operating system loader and other basic information needed during startup.

As the system boots, the LEDs indicate the status of the boot block and firmware initialization and whether the system performed the steps correctly. If there is an error during startup, you can use the LED display to identify it.

[Table 3-4](#) displays the LEDs and execution states for the boot block. [Table 3-5](#) displays the LEDs and execution states during firmware initialization. The LEDs display in hexadecimal format so that you can determine the number and the corresponding execution state from the LEDs that display.

Table 3-4. Boot Block States

LED	Execution State
0x01	Setup 8-bit Bus for access to Flash and 8 Bit devices successful
0x03	Serial port initialization successful
0x04	Spd (cache memory) read successful
0x05	SDRAM refresh initialization sequence successful
0x07	Start ECC initialization and memory scrub
0x08	End ECC initialization and memory scrub
0x10	SDRAM is present and properly configured. About to program ATU.
0x11	CRC check on the firmware image successful. Continue to load firmware.
0x12	Initialization of SCSI chips successful.
0x13	BIOS protocols ports initialized. About to load firmware.
0x17	Firmware is either corrupt or BIOS disabled. Firmware was not loaded.
0x19	Error ATU ID programmed.
0x55	System Halt: Battery Backup Failure

Table 3-5. Firmware Initialization States

LED	Execution State
0x1	Begin Hardware Initialization
0x3	Begin Initialize ATU
0x7	Begin Initialize Debug Console
0xF	Set if Serial Loopback Test is successful

Step 9 Run the BIOS Configuration Utility or Dell Manager

Press <Ctrl><M> when prompted during the boot process to run the BIOS Configuration Utility. You can run Dell Manager in Red Hat Linux to perform the same functions, such as configuring arrays and logical drives.

See [BIOS Configuration Utility and Dell Manager](#) for additional information about running the BIOS Configuration Utility and Dell Manager.

Step 10 Install an Operating System

Install one of the following operating systems: Microsoft® Windows NT®, Windows® 2000, Windows 2003, Novell® NetWare®, and Red Hat Linux.

Step 11 Install the Operating System Driver

Operating system drivers are provided on the *Dell OpenManage Systems Management* CD that accompanies your PERC controller. See the *CERC and PERC RAID Controllers Operating System Driver Installation Guide* for additional information about installing the drivers for the operating systems.

 **NOTE:** To make sure you have the latest version of the drivers, download the updated drivers from the Dell Support web site at support.dell.com.

[Back to Contents Page](#)

[Back to Contents Page](#)

Configuring the RAID Controller

Dell™ PowerEdge™ Expandable RAID Controller 4/SC and 4/DC User's Guide

- [Configuring SCSI Physical Drives](#)
- [Physical Device Layout](#)
- [Device Configuration](#)
- [Setting Hardware Termination](#)
- [Configuring Arrays](#)
- [Assigning RAID Levels](#)
- [Optimizing Data Storage](#)

This section describes how to configure for physical drives, arrays, and logical drives. It contains tables you can complete to list the configuration for the physical drives and logical drives.

Configuring SCSI Physical Drives

Your SCSI hard drives must be organized into logical drives in an array and must be able to support the RAID level that you select.

Observe the following guidelines when connecting and configuring SCSI devices in a RAID array:

- 1 You can place up to 32 physical drives in an array.
 - 1 When implementing RAID 1 or RAID 5, disk space is spanned to create the stripes and mirrors. The span size can vary to accommodate the different disk sizes. There is, however, the possibility that a portion of the largest disk in the array will be unusable, resulting in wasted disk space. For example, consider an array that has the following disks:
 - o Disk A = 40 GB
 - o Disk B = 40 GB
 - o Disk C = 60 GB
 - o Disk D = 80 GB

In this example, data is spanned across all four disks until Disk A and Disk B and 40 GB on each of Disk C and D are completely full. Data is then spanned across Disks C and D until Disk C is full. This leaves 20 GB of disk space remaining on Disk D. Data cannot be written to this disk space, as there is no corresponding disk space available in the array to create redundant data.

- 1 For RAID levels 10 and 50, the additional space in larger arrays can store data, so you can use arrays of different sizes.
 - 1 When replacing a failed hard drive, make sure that the replacement drive has a capacity that is the same size or larger than the smallest drive in a logical drive that supports redundancy (RAID 1, 5, 10, and 50).
-

Physical Device Layout

Use [Table 4-1](#) to list the details for each physical device on the channels.

Table 4-1. Physical Device Layout

	Channel 0	Channel 1
Target ID		
Device type		
Logical drive number/ drive number		
Manufacturer/model number		
Firmware level		
Target ID		
Device type		

Logical drive number/ drive number		
Manufacturer/model number		
Firmware level		
Target ID		
Device type		
Logical drive number/ drive number		
Manufacturer/model number		
Firmware level		
Target ID		
Device type		
Logical drive number/drive number		
Manufacturer/model number		
Firmware level		
Target ID		
Device type		
Logical drive number/drive number		
Manufacturer/model number		
Firmware level		
Target ID		
Device type		
Logical drive number/drive number		
Manufacturer/model number		
Firmware level		
Target ID		
Device type		
Logical drive number/drive number		
Manufacturer/model number		
Firmware level		
Target ID		
Device type		
Logical drive number/drive number		
Manufacturer/model number		
Firmware level		
Target ID		
Device type		
Logical drive number/drive number		
Manufacturer/model number		
Firmware level		
Target ID		
Device type		
Logical drive number/drive number		
Manufacturer/model number		
Firmware level		
Target ID		
Device type		
Logical drive number/drive number		
Manufacturer/model number		
Firmware level		
Target ID		
Device type		
Logical drive number/drive number		
Manufacturer/model number		
Firmware level		
Target ID		
Device type		
Logical drive number/drive number		
Manufacturer/model number		
Firmware level		
Target ID		
Device type		
Logical drive number/drive number		
Manufacturer/model number		
Firmware level		
Target ID		
Device type		

Device type		
Logical drive number/drive number		
Manufacturer/model number		
Firmware level		

Device Configuration

The following contain tables you can fill out to list the devices assigned to each channel. The PERC 4/SC controller has one channel; the PERC 4/DC has two.

Use [Table 4-2](#) to list the devices that you assign to each SCSI ID for SCSI Channel 0.

Table 4-2. Configuration for SCSI Channel 0

SCSI Channel 0	
SCSI ID	Device Description
0	
1	
2	
3	
4	
5	
6	
7	Reserved for host controller.
8	
9	
10	
11	
12	
13	
14	
15	

Use [Table 4-3](#) to list the devices that you assign to each SCSI ID for SCSI Channel 1.

Table 4-3. Configuration for SCSI Channel 1

SCSI Channel 1	
SCSI ID	Device Description
0	
1	
2	
3	
4	
5	
6	
7	Reserved for host controller.
8	
9	
10	
11	
12	
13	
14	
15	

Setting Hardware Termination

 **NOTE:** If you are using the PERC 4/DC RAID controller for clustering, then you must use hardware termination. Otherwise, software termination is OK.

The SCSI bus is an electrical transmission line and must be terminated properly to minimize reflections and losses. Termination should be set at each end of the SCSI cable(s).

- 1 J5 Termination Enable is a three-pin header that specifies control of the SCSI termination for channel 0.
- 1 J6 Termination Enable is a three-pin header that specifies control of the SCSI termination for channel 1.

To enable hardware termination, leave the pins open. The default is hardware termination.

 **NOTE:** See "[Step 7 Set SCSI Termination](#)" for additional information about setting SCSI termination.

Configuring Arrays

Organize the physical drives into arrays after the drives are connected to the RAID controller, formatted, and initialized. An array can consist of up to 28 physical drives (24 drives when used with the span feature in a RAID 50 configuration).

The number of drives in an array determines the RAID levels that can be supported. The RAID controller supports up to 40 logical drives per controller.

Creating Hot Spares

Any drive that is present, formatted, and initialized, but not included in an array or logical drive can be designated as a hot spare. You can use the RAID management utilities to designate drives as hot spares. The utilities are described in the [RAID Management Utilities](#) section.

Creating Logical Drives

Logical drives are arrays or spanned arrays that are presented to the operating system. The logical drive capacity can also be larger than an array by using spanning. The RAID controller supports up to 40 logical drives.

Configuration Strategies

The most important factors in RAID array configuration are drive capacity, drive availability (fault tolerance), and drive performance.

You cannot configure a logical drive that optimizes all three factors, but it is easy to select a logical drive configuration that maximizes one or two factors at the expense of the other factor(s).

Configuring Logical Drives

After you have installed the RAID controller in the server and have attached all physical drives, perform the following steps to prepare a RAID disk array:

1. Start the system.
2. Press <Ctrl><M> during bootup to run the BIOS Configuration Utility.
3. Select **Easy Configuration**, **New Configuration**, or **View/Add Configuration** in [BIOS Configuration Utility and Dell Manager](#) to customize the RAID array.
4. Create and configure one or more system drives (logical drives).

5. Select the RAID level, cache policy, read policy, and write policy.
6. Save the configuration.
7. Initialize the system drives.
8. Install the operating system.

See [BIOS Configuration Utility and Dell Manager](#) for detailed instructions.

Logical Drive Configuration

Use [Table 4-4](#) to list the details for each logical drive that you configure.

Table 4-4. Logical Drive Configuration

Logical Drive	RAID Level	Stripe Size	Logical Drive Size	Cache Policy	Read Policy	Write Policy	Number of Physical Drives
LD0							
LD1							
LD2							
LD3							
LD4							
LD5							
LD6							
LD7							
LD8							
LD9							
LD10							
LD11							
LD12							
LD13							
LD14							
LD15							
LD16							
LD17							
LD18							
LD19							
LD20							
LD21							
LD22							
LD23							
LD24							
LD25							
LD26							
LD27							
LD28							
LD29							
LD30							
LD31							
LD32							
LD33							
LD34							
LD35							
LD36							
LD37							
LD38							
LD39							

Assigning RAID Levels

Only one RAID level can be assigned to each logical drive. [Table 4-5](#) shows the minimum and maximum number of drives required.

Table 4-5. Physical Drives Required for Each RAID Level

RAID Level	Minimum # of Physical Drives	Maximum # of Physical Drives for PERC 4/SC	Maximum # of Physical Drives for PERC 4/DC
0	1	14	28
1	2	2	2
5	3	14	28
10	4	14	28
50	6	14	28

Summary of RAID Levels

RAID 0 uses striping to provide high data throughput, especially for large files in an environment that does not require fault tolerance.

RAID 1 uses mirroring and is good for small databases or other applications that require small capacity, but complete data redundancy.

RAID 5 provides high data throughput, especially for small random access. Use this level for any application that requires high read request rates, but low write request rates, such as transaction processing applications. Write performance is significantly lower for RAID 5 than for RAID 0 and RAID 1.

RAID 10 consists of striped data across mirrored spans. It provides high data throughput and complete data redundancy, but uses a larger number of spans.

RAID 50 uses parity and disk striping and works best with data that requires high reliability, high request rates, high data transfers, and medium-to-large capacity. Write performance is limited to the same as RAID 5.

Storage in RAID 10 and RAID 50 Arrays of Different Sizes

For RAID levels 10 and 50, the additional space in larger arrays can store data, so you can use arrays of different sizes. [Figure 4-1](#) shows the example of a RAID 50 array with three RAID 5 arrays of different sizes. Data is striped across the three arrays until the smallest drive is full. The data is then striped across the larger two arrays until the smaller of those two arrays is full. Finally, data is stored in the additional space in the largest of the three arrays.

Performance Considerations

Performance is better the more spans there are. As the storage space in the spans is filled, the system stripes data over fewer and fewer spans and RAID performance degrades to that of a RAID 1 or RAID 5 array.

Figure 4-1. Storage in a RAID 50 Array

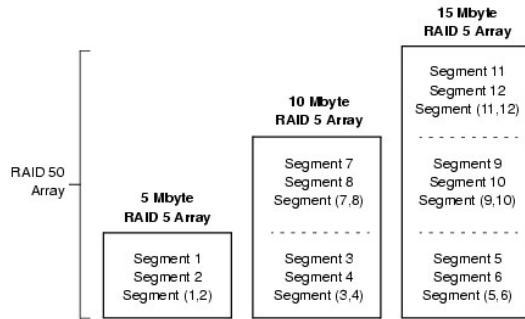

Optimizing Data Storage

Data Access Requirements

Each type of data stored in the disk subsystem has a different frequency of read and write activity. If you know the data access requirements, you can more successfully determine a strategy for optimizing the disk subsystem capacity, availability, and performance. For example, servers that support Video on Demand typically read the data often, but write data infrequently. Both the read and write operations tend to be long. Data stored on a general-purpose file server involves relatively short read and write operations with relatively small files.

Array Considerations

You must identify the purpose of the data to be stored in the disk subsystem before you can confidently select a RAID level and a RAID configuration. Will this array increase the system storage capacity for general-purpose file and print servers? Does this array support any software system that must be available 24 hours per day? Will the information stored in this array contain large audio or video files that must be available on demand? Will this array contain data from an imaging system?

[Back to Contents Page](#)

[Back to Contents Page](#)

BIOS Configuration Utility and Dell Manager

Dell™ PowerEdge™ Expandable RAID Controller 4/SC and 4/DC User's Guide

- [Starting the BIOS Configuration Utility](#)
- [Starting Dell Manager](#)
- [Using Dell Manager in Red Hat Linux GUI Mode](#)
- [Configuring Arrays and Logical Drives](#)
- [Designating Drives as Hot Spares](#)
- [Creating Arrays and Logical Drives](#)
- [Drive Roaming](#)
- [Initializing Logical Drives](#)
- [Deleting Logical Drives](#)
- [Clearing Physical Drives](#)
- [Rebuilding Failed Hard Drives](#)
- [Using a Pre-loaded SCSI Drive "As-is"](#)
- [FlexRAID Virtual Sizing](#)
- [Checking Data Consistency](#)
- [Reconstructing Logical Drives](#)
- [Exiting the Configuration Utility](#)

The BIOS Configuration Utility configures disk arrays and logical drives. Because the utility resides in the RAID controller BIOS, its operation is independent of the operating systems on your system.

Dell™ Manager is a character-based, non-GUI utility that changes policies, and parameters, and monitors RAID systems. Dell Manager runs under Red Hat Linux, Advanced Server, Enterprise.

Use these utilities to do the following:

- 1 Create hot spare drives.
- 1 Configure physical arrays and logical drives.
- 1 Initialize one or more logical drives.
- 1 Access controllers, logical drives, and, physical drives individually.
- 1 Rebuild failed hard drives.
- 1 Verify that the redundancy data in logical drives using RAID level 1, 5, 10, or 50 is correct.
- 1 Reconstruct logical drives after changing RAID levels or adding a hard drive to an array
- 1 Select a host controller to work on.

Starting the BIOS Configuration Utility

When the host computer boots, hold the <Ctrl> key and press the <M> key when a BIOS banner such as the following appears:

```
HA -0 (Bus X Dev X) Type: PERC 4 Standard FWx.xx SDRAM=128MB
```

```
Battery Module is Present on Adapter
```

```
1 Logical Drive found on the Host Adapter
```

```
Adapter BIOS Disabled, No Logical Drives handled by BIOS
```

0 Logical Drive(s) handled by BIOS

Press <Ctrl><M> to Enable BIOS

For each controller in the host system, the firmware version, dynamic random access memory (DRAM) size, and the status of logical drives on that controller display. After you press a key to continue, the **Management Menu** screen displays.

 **NOTE:** In the BIOS Configuration Utility, pressing <Ctrl><M> has the same effect as pressing <Enter>.

Starting Dell Manager

Make sure the program file is in the correct directory before you enter the command to start Dell Manager. For Linux, use the Dell Manager RPM to install files in the usr/sbin directory. The RPM installs them automatically in that directory.

Type `dellmgr` to start the program.

Using Dell Manager in Red Hat Linux GUI Mode

On a Red Hat Linux system, for Dell Manager to work correctly in a terminal in GUI Mode, you must set the terminal type to linux and keyboard mappings.

Perform the procedure below if you use konsole, gnome terminal, or xterm.

The linux console mode, which you select from the terminal with the **File → Linux Console** command, works correctly by default. The text mode console (non-GUI) also works correctly by default.

To prepare the system to use Dell Manager, perform the following steps:

1. Start the Terminal.
2. Before you enter `dellmgr` to start Dell Manager, type the following commands:

```
TERM=linux
```

```
Export TERM
```

3. Select **Settings→ Keyboard→ Linux Console** from the Terminal menu.

 **NOTE:** On a Red Hat Linux 8.x system, when you run Dell Manager (v. x.xx) from a Gnome-terminal in XWindows, the <F10> key cannot be used to create a logical drive. Instead, use the alternate keys <Shift><0>. (This is not an issue if Xterm is used to call dellmgr). The following is a list of alternate keys you can use in case of problems with keys <F1> through <F7>, and <F10>:

- 1 <Shift><1> for <F1>
 - 1 <Shift><2> for <F2>
 - 1 <Shift><3> for <F3>
 - 1 <Shift><4> for <F4>
 - 1 <Shift><5> for <F5>
 - 1 <Shift><6> for <F6>
 - 1 <Shift><7> for <F7>
 - 1 <Shift><0> for <F10>
-

Configuring Arrays and Logical Drives

1. Designate hot spares (optional).

See [Designating Drives as Hot Spares](#) in this section for more information.

2. Select a configuration method.

See [Creating Arrays and Logical Drives](#) in this section for more information.

3. Create arrays using the available physical drives.
4. Define logical drives using the arrays.
5. Save the configuration information.
6. Initialize the logical drives.

See [Initializing Logical Drives](#) in this section for more information.

Designating Drives as Hot Spares

Hot spares are physical drives that are powered up along with the RAID drives and usually stay in a standby state. If a hard drive used in a RAID logical drive fails, a hot spare will automatically take its place and the data on the failed drive is reconstructed on the hot spare. Hot spares can be used for RAID levels 1, 5, 10, and 50. Each controller supports up to eight hot spares.

The methods for designating physical drives as hot spares are:

1. Pressing <F4> while creating arrays in **Easy**, **New** or **View/Add Configuration** mode.
1. Using the **Objects—> Physical Drive** menu.

<F4> Key

When you select any configuration option, a list of all physical devices connected to the current controller appears. Perform the following steps to designate a drive as a hot spare:

1. On the **Management Menu** select **Configure**, then a configuration option.
2. Press the arrow keys to highlight a hard drive that displays as **READY**.
3. Press <F4> to designate the drive as a hot spare.
4. Click **YES** to make the hot spare.

The drive displays as **HOTSP**.

5. Save the configuration.

Objects Menu

1. On the **Management Menu** select **Objects—> Physical Drive**.

A physical drive selection screen appears.

2. Select a hard drive in the **READY** state and press <Enter> to display the action menu for the drive.
3. Press the arrow keys to select **Make HotSpare** and press <Enter>.





The selected drive displays as **HOTSP**.

Creating Arrays and Logical Drives

Configure arrays and logical drives using **Easy Configuration**, **New Configuration**, or **View/Add Configuration**. See [Using Easy Configuration](#), [Using New Configuration](#), or [Using View/Add Configuration](#) for the configuration procedures.

After you create an array or arrays, you can select the parameters for the logical drive. [Table 5-1](#) contains descriptions of the parameters.

Table 5-1. Logical Drive Parameters and Descriptions

Parameter	Description
RAID Level	The number of physical drives in a specific array determines the RAID levels that can be implemented with the array.
Stripe Size	<p>Stripe Size specifies the size of the segments written to each drive in a RAID 1, 5, or 10 logical drive. You can set the stripe size to 2 KB, 4 KB, 8 KB, 16 KB, 32 KB, 64 KB, or 128 KB. The default is 64 KB.</p> <p>A larger stripe size provides better read performance, especially if your computer does mostly sequential reads. However, if you are sure that your computer does random read requests more often, select a small stripe size.</p> <p> NOTE: Using a 2 KB or 4 KB stripe size is not recommended.</p>
Write Policy	<p>Write Policy specifies the cache write policy. You can set the write policy to Write-back or Write-through.</p> <p>In Write-back caching, the controller sends a data transfer completion signal to the host when the controller cache has received all the data in a transaction. This setting is recommended in standard mode.</p> <p> NOTICE: If WriteBack is enabled and the system is quickly turned off and on, the RAID controller may hang when flushing cache memory. Controllers that contain a battery backup will default to WriteBack caching.</p> <p>In Write-through caching, the controller sends a data transfer completion signal to the host when the disk subsystem has received all the data in a transaction.</p> <p>Write-through caching has a data security advantage over write-back caching. Write-back caching has a performance advantage over write-through caching.</p> <p> NOTE: You should not use write-back for any logical drive that is to be used as a <i>Novell NetWare volume</i>.</p> <p> NOTE: Enabling clustering turns off write cache. PERC 4/DC supports clustering.</p>
Read Policy	<p>Read-ahead enables the read-ahead feature for the logical drive. You can set this parameter to Read-Ahead, No-Read-ahead, or Adaptive. The default is Adaptive.</p> <p>Read-ahead specifies that the controller uses read-ahead for the current logical drive. Read-ahead capability allows the adapter to read sequentially ahead of requested data and store the additional data in cache memory, anticipating that the data will be needed soon. Read-ahead supplies sequential data faster, but is not as effective when accessing random data.</p> <p>No-Read-Ahead specifies that the controller does not use read-ahead for the current logical drive.</p> <p>Adaptive specifies that the controller begins using read-ahead if the two most recent disk accesses occurred in sequential sectors. If all read requests are random, the algorithm reverts to No-Read-Ahead; however, all requests are still evaluated for possible sequential operation.</p>
Cache Policy	<p>Cache Policy applies to reads and writes on a specific logical drive. It does not affect the Read-ahead cache. The default is Direct I/O.</p> <p>Cached I/O specifies that all reads and writes are buffered in cache memory.</p> <p>Direct I/O specifies that reads and writes are not buffered in cache memory. Direct I/O does not override the cache policy settings. Data is transferred to cache and the host concurrently. If the same data block is read again, it comes from cache memory.</p>
Span	<p>The choices are:</p> <p>Yes—Array spanning is enabled for the current logical drive. The logical drive can occupy space in more than one array.</p> <p>No—Array spanning is disabled for the current logical drive. The logical drive can occupy space in only one array.</p> <p>The RAID controller supports spanning of RAID 1 and 5 arrays. You can span two or more RAID 1 arrays into a RAID 10 array and two or more RAID 5 arrays into a RAID 50 array.</p> <p>For two arrays to be spanned, they must have the same stripe width (they must contain the same number of physical drives).</p>

Using Easy Configuration

In **Easy Configuration**, each physical array you create is associated with exactly one logical drive. You can modify the following parameters:

- 1 RAID level
- 1 Stripe size
- 1 Write policy
- 1 Read policy
- 1 Cache policy

If logical drives have already been configured when you select **Easy Configuration**, the configuration information is not disturbed. Perform the following steps to create arrays and logical drives using **Easy Configuration**.

1. Select **Configure**—> **Easy Configuration** from the **Management Menu**.

Hot key information displays at the bottom of the screen.

2. Press the arrow keys to highlight specific physical drives.
3. Press the spacebar to associate the selected physical drive with the current array.

The selected drive changes from **READY** to **ONLIN A[*array number*]-[*drive number*]**. For example, **ONLIN A2-3** means array 2 with hard drive 3.

4. Add physical drives to the current array as desired.

Try to use drives of the same capacity in a specific array. If you use drives with different capacities in an array, all drives in the array are treated as if they have the capacity of the smallest drive in the array.

5. Press <Enter> after you finish creating the current array.

The **Select Configurable Array(s)** window appears. It displays the array and array number, such as **A-00**.

6. Press the spacebar to select the array.

Span information displays in the array box. You can create multiple arrays, then select them to span them.



NOTE: You can press <F2> to display the number of drives in the array, their channel and ID, and <F3> to display array information, such as the stripes, slots, and free space.

7. Press <F10> to configure logical drives.

The window at the top of the screen shows the logical drive that is currently being configured.

8. Highlight **RAID** and press <Enter> to set the RAID level for the logical drive.

The available RAID levels for the current logical drive display.

9. Select a RAID level and press <Enter> to confirm.
10. Click **Advanced Menu** to open the menu for logical drive settings.
11. Set the **Stripe Size**.
12. Set the **Write Policy**.
13. Set the **Read Policy**.
14. Set the **Cache Policy**.
15. Press <Esc> to exit the **Advanced Menu**.
16. After you define the current logical drive, select **Accept** and press <Enter>.

The array selection screen appears if any unconfigured hard drives remain.

 **NOTE:** The PERC 4 family supports spanning across RAID 1 and 5 arrays only.

17. Repeat [step 2](#) through [step 16](#) to configure another array and logical drive.

The RAID controller supports up to 40 logical drives per controller.

18. When finished configuring logical drives, press <Esc> to exit **Easy Configuration**.

A list of the currently configured logical drives appears.

19. Respond to the **Save** prompt.

After you respond to the Save prompt, the **Configure** menu appears.

20. Initialize the logical drives you have just configured.

See "[Initializing Logical Drives](#)" in this section for more information.

Using New Configuration

If you select **New Configuration**, the existing configuration information on the selected controller is *destroyed when the new configuration is saved*. In **New Configuration**, you can modify the following logical drive parameters:

- 1 RAID level
- 1 Stripe size
- 1 Write policy
- 1 Read policy
- 1 Cache policy
- 1 Logical drive size
- 1 Spanning of arrays

 **NOTICE:** Selecting **New Configuration** *erases* the existing configuration information on the selected controller. To use the spanning feature and keep the existing configuration, use **View/Add Configuration**.

1. Select **Configure**—> **New Configuration** from the **Management Menu**.

Hot key information appears at the bottom of the screen.

2. Press the arrow keys to highlight specific physical drives.
3. Press the spacebar to associate the selected physical drive with the current array.

The selected drive changes from **READY** to **ONLINE A[*array number*]-[*drive number*]**. For example, **ONLINE A2-3** means array 2 with hard drive 3.

4. Add physical drives to the current array as desired.

 **NOTE:** Try to use drives of the same capacity in a specific array. If you use drives with different capacities in an array, all drives in the array are treated as if they have the capacity of the smallest drive in the array.

5. Press <Enter> after you finish creating the current array.

The **Select Configurable Array(s)** window appears. It displays the array and array number, such as **A-00**.

6. Press the spacebar to select the array.

Span information displays in the array box. You can create multiple arrays, then select them to span them.

 **NOTE:** You can press <F2> to display the number of drives in the array, their channel and ID, and <F3> to display array information, such as the stripes, slots, and free space.

7. Repeat [step 2](#) through [step 6](#) to create another array or go to [step 8](#) to configure a logical drive.
8. Press <F10> to configure a logical drive.

The logical drive configuration screen appears. **Span=Yes** displays on this screen if you select two or more arrays to span.

The window at the top of the screen shows the logical drive that is currently being configured as well as any existing logical drives.

9. Highlight **RAID** and press <Enter> to set the RAID level for the logical drive.

A list of the available RAID levels for the current logical drive appears.

10. Select a RAID level and press <Enter> to confirm.
11. Highlight **Span** and press <Enter>.
12. Highlight a spanning option and press <Enter>.

 **NOTE:** The PERC 4 family supports spanning for RAID 1 and RAID 5 only. You can configure RAID 10 by spanning two or more RAID 1 logical drives. You can configure RAID 50 by spanning two or more RAID 5 logical drives. The logical drives must have the same stripe size.

13. Move the cursor to **Size** and press <Enter> to set the logical drive size.

 **NOTE:** The full drive size is used when you span logical drives; you cannot specify a smaller drive size.

By default, the logical drive size is set to all available space in the array(s) being associated with the current logical drive, accounting for the **Span** setting.

14. Click **Advanced Menu** to open the menu for logical drive settings.
15. Set the **Stripe Size**.
16. Set the **Write Policy**.
17. Set the **Read Policy**.
18. Set the **Cache Policy**.
19. Press <Esc> to exit the **Advanced Menu**.
20. After you define the current logical drive, select **Accept** and press <Enter>.

If space remains in the arrays, the next logical drive to be configured appears. If the array space has been used, a list of the existing logical drives appears.

21. Press any key to continue, then respond to the **Save** prompt.
22. Initialize the logical drives you have just configured.

See [Initializing Logical Drives](#) in this section for more information.

Using View/Add Configuration

View/Add Configuration allows you to control the same logical drive parameters as **New Configuration** *without disturbing* the existing configuration information. In addition, you can enable the **Configuration on Disk** feature.

1. Select **Configure**—> **View/Add Configuration** from the **Management Menu**.

Hot key information appears at the bottom of the screen.

2. Press the arrow keys to highlight specific physical drives.
3. Press the spacebar to associate the selected physical drive with the current array.

The selected drive changes from **READY** to **ONLIN A[*array number*]-[*drive number*]**. For example, **ONLIN A2-3** means array 2 with hard drive 3.

4. Add physical drives to the current array as desired.

 **NOTE:** Try to use drives of the same capacity in a specific array. If you use drives with different capacities in an array, all drives in the array are treated as if they have the capacity of the smallest drive in the array.

5. Press <Enter> after you finish creating the current array.

The **Select Configurable Array(s)** window appears. It displays the array and array number, such as A-00.

6. Press the spacebar to select the array.

Span information, such as **Span-1**, displays in the array box. You can create multiple arrays, then select them to span them.

 **NOTE:** You can press <F2> to display the number of drives in the array, their channel and ID, and <F3> to display array information, such as the stripes, slots, and free space.

7. Press <F10> to configure a logical drive.

The logical drive configuration screen appears. **Span=Yes** displays on this screen if you select two or more arrays to span.

8. Highlight **RAID** and press <Enter> to set the RAID level for the logical drive.

The available RAID levels for the current logical drive appear.

9. Select a RAID level and press <Enter> to confirm.
10. Highlight **Span** and press <Enter>.
11. Highlight a spanning option and press <Enter>.
12. Move the cursor to **Size** and press <Enter> to set the logical drive size.

By default, the logical drive size is set to all available space in the array(s) associated with the current logical drive, accounting for the **Span** setting.

13. Highlight **Span** and press <Enter>.
14. Highlight a spanning option and press <Enter>.

 **NOTE:** The full drive size is used when you span logical drives; you cannot specify a smaller drive size.

15. Open the **Advanced Menu** to open the menu for logical drive settings.
16. Set the **Stripe Size**.
17. Set the **Write Policy**.
18. Set the **Read Policy**.
19. Set the **Cache Policy**.
20. Press <Esc> to exit the **Advanced Menu**.
21. After you define the current logical drive, select **Accept** and press <Enter>.

If space remains in the arrays, the next logical drive to be configured appears.

22. Repeat [step 2](#) to [step 21](#) to create an array and configure another logical drive.

If all array space is used, a list of the existing logical drives appears.

23. Press any key to continue, then respond to the **Save** prompt.
24. Initialize the logical drives you have just configured.

See "[Initializing Logical Drives](#)" in this section for more information.

Drive Roaming

Drive roaming (also known as configuration on disk) occurs when the hard drives are changed to different channels on the same controller. When the drives are placed on different channels, the controller detects the RAID configuration from the configuration data on the drives. See [Drive Roaming](#) in the [RAID Controller Features](#) section for more information. Perform the following steps to add support for drive roaming:

1. Press <Ctrl><M> during system boot to run the BIOS Configuration Utility.
 2. Select **Configure**—> **View/Add Configuration**.
 3. Select **Disk** when asked to use **Disk** or **NVRAM**.
 4. Select **Save**.
 5. Press <Esc> to exit the BIOS Configuration Utility.
 6. Reboot the computer.
-

Initializing Logical Drives

Initialize each new logical drive you configure. You can initialize the logical drives individually or in batches (up to 40 simultaneously).

Batch Initialization

1. Select **Initialize** from the **Management Menu**.

A list of the current logical drives appears.

2. Press the spacebar to select the desired logical drive for initialization.
3. Press <F2> to select/deselect all logical drives.
4. After you finish selecting logical drives, press <F10> and select **Yes** from the confirmation prompt.

The progress of the initialization for each drive is shown in bar graph format.

5. When initialization is complete, press any key to continue or press <Esc> to display the **Management Menu**.

Individual Initialization

1. Select the **Objects**—> **Logical Drive** from the **Management Menu**.
2. Select the logical drive to be initialized.
3. Select **Initialize** from the action menu.

Initialization progress appears as a bar graph on the screen.

4. When initialization completes, press any key to display the previous menu.
-

Deleting Logical Drives

This RAID controller supports the ability to delete any unwanted logical drives and use that space for a new logical drive. You can have an array with multiple logical drives and delete a logical drive without the whole array.

After you delete a logical drive, you can create a new one. You can use the configuration utilities to create the next logical drive from the non-contiguous free space (‘holes’), and from the newly created arrays. The configuration utility provides a list of configurable arrays where there is a space to configure.

 **NOTICE:** The deletion of the logical drive can fail under certain conditions: During a rebuild, initialization or check consistency of a logical drive, if that drive has a higher logical drive number than the drive you want to delete.

To delete logical drives, perform the following steps:

1. Select **Objects—> Logical Drive** from the **Management Menu**.

The logical drives display.

2. Use the arrow key to highlight the logical drive you want to delete.
3. Press <F5> to delete the logical drive.

This deletes the logical drive and makes the space it occupied available for you to make another logical drive.

Clearing Physical Drives

You can clear the data from SCSI drives using the configuration utilities. To clear a drive, perform the following steps:

1. Select **Management Menu—> Objects—> Physical Drives** in the BIOS Configuration Utility.

A device selection window displays the devices connected to the current controller.

2. Press the arrow keys to select the physical drive to be cleared and press <Enter>.
3. Select **Clear**.
4. When clearing completes, press any key to display the previous menu.

 **CAUTION:** Do not terminate the clearing process, as it makes the drive unusable. The drive would have to be cleared again.

Displaying Media Errors

Check the **View Drive Information** screen for the drive to be formatted. Perform the following steps to display this screen which contains the media errors:

1. Select **Objects—> Physical Drives** from the **Management Menu**.
2. Select a device.
3. Press <F2>.

The error count displays at the bottom of the properties screen as they occur. If you feel that the number of errors is excessive, you should probably clear the hard drive. You do not have to select **Clear** to erase existing information on your SCSI disks, such as a DOS partition. That information is erased when you initialize logical drives.

Rebuilding Failed Hard Drives

If a hard drive fails in an array that is configured as a RAID 1, 5, 10, or 50 logical drive, you can recover the lost data by rebuilding the drive.

Rebuild Types

[Table 5-2](#) describes automatic and manual rebuilds.

Table 5-2. Rebuild Types

Type	Description
Automatic Rebuild	If you have configured hot spares, the RAID controller automatically tries to use them to rebuild failed disks. Select Objects—> Physical Drive to display the physical drives screen while a rebuild is in progress. The drive for the hot spare drive changes to REBLD A[<i>array number</i>]-[<i>drive number</i>] , indicating the hard drive being replaced by the hot spare.
Manual Rebuild	Manual rebuild is necessary if no hot spares with enough capacity to rebuild the failed drives are available. Use the following procedures to rebuild a failed drive manually.

Manual Rebuild – Rebuilding an Individual Drive

1. Select **Objects—> Physical Drive** from the **Management Menu**.

A device selection window displays the devices connected to the current controller.

2. Press the arrow keys to select the physical drive to rebuild, then press <Enter>.
3. Select **Rebuild** from the action menu and respond to the confirmation prompt.

Rebuilding can take some time, depending on the drive capacity.

4. When the rebuild is complete, press any key to display the previous menu.

Manual Rebuild – Batch Mode

1. Select **Rebuild** from the **Management Menu**.

A device selection window displays the devices connected to the current controller. The failed drives display as **FAIL**.

2. Press the arrow keys to highlight any failed drives to be rebuilt.
3. Press the spacebar to select the desired physical drive for rebuild.
4. After you select the physical drives, press <F10> and select **Yes** at the prompt.

The selected drives change to **REBLD**. Rebuilding can take some time, depending on the number of drives selected and the drive capacities.

5. When the rebuild is complete, press any key to continue.
6. Press <Esc> to display the **Management Menu**.

Using a Pre-loaded SCSI Drive "As-is"

 **NOTE:** To use a pre-loaded system drive in the manner described here, you must make it the first logical drive defined (for example: LD1) on the controller it is connected to. This will make the drive ID 0 LUN 0. If the drive is not a boot device, the logical drive number is not critical.

If you have a SCSI hard drive that is already loaded with software and the drive is a boot disk containing an operating system, add the PERC device driver to this system drive before you switch to the RAID controller and attempt to boot from it. Perform the following steps:

1. Connect the SCSI drive to the channel on the RAID controller, with proper termination and target ID settings.
2. Boot the computer.
3. Start the configuration utility by pressing <Ctrl><M>.
4. Select **Configure—> Easy Configuration**.
5. Press the cursor keys to select the pre-loaded drive.
6. Press the spacebar.

The pre-loaded drive should now become an array element.

7. Press <Enter>.

You have now declared the pre-loaded drive as a one-disk array.

8. Set the **Read Policy** and **Cache Policy** on the **Advanced Menu**.
9. Exit the **Advanced Menu**.
10. Highlight **Accept** and press <Enter>.

Do not initialize.

11. Press <Esc> and select **Yes** at the Save prompt.
 12. Exit the configuration utility and reboot.
 13. Set the host system to boot from SCSI, if such a setting is available.
-

FlexRAID Virtual Sizing

The **FlexRAID Virtual Sizing** option can no longer be enabled. It was used to allow Windows NT® and Novell® NetWare® 5.1 to use the new space of a RAID array immediately after you added capacity online or performed a reconstruction.

FlexRAID Virtual Sizing is in the BIOS Configuration Utility. If you have this option enabled on older cards, you need to disable it, then upgrade the firmware. Perform the following steps to do this:

1. Go to the support.dell.com web site.
2. Download the latest firmware and driver to a diskette.

The firmware is an executable file that downloads the files to the diskette in your system.

3. Restart the system and boot from the diskette.
 4. Run `pflash` to flash the firmware.
-

Checking Data Consistency

Select this option to verify the redundancy data in logical drives that use RAID levels 1, 5, 10, and 50. (RAID 0 does not provide data redundancy.)

The parameters of the existing logical drives appear. Discrepancies are automatically corrected, *assuming always that the data is correct*. However, if the failure is a read error on a data drive, the bad data block is reassigned with the generated data.

Perform the following steps to run **Check Consistency**:

1. Select **Check Consistency** from the **Management Menu**.
2. Press the arrow keys to highlight the desired logical drives.
3. Press the spacebar to select or deselect a drive for consistency checking.
4. Press <F2> to select or deselect all the logical drives.
5. Press <F10> to begin the consistency check.

A progress graph for each selected logical drive displays.

6. When the check is finished, press any key to clear the progress display.
7. Press <Esc> to display the Management Menu.

(To check an individual drive, select **Objects—> Logical Drives** from the **Management Menu**, the desired logical drive(s), then **Check Consistency** on the action menu.)

 **NOTE:** Stay at the **Check Consistency** menu until the check is complete.

Reconstructing Logical Drives

A reconstruction occurs when you change the RAID level of an array or add a physical drive to an existing array. Perform the following steps to reconstruct a drive:

1. Move the arrow key to highlight **Reconstruct** on the **Management Menu**.
2. Press <Enter>.

The window entitled "**Reconstructables**" displays. This contains the logical drives that can be reconstructed. You can press <F2> to view logical drive information or <Enter> to select the reconstruct option.

3. Press <Enter>.

The next reconstruction window displays. The options on this window are <spacebar> to select a drive, <Enter> to open the reconstruct menu, and <F3> to display logical drive information.

4. Press <Enter> to open the reconstruct menu.

The menu items are RAID level, stripe size, and reconstruct.

5. To change the RAID level, select **RAID** with the arrow key, and press <Enter>.
6. Select **Reconstruct** and press <Enter> to reconstruct the logical drive.

 **NOTE:** Once you start the reconstruct process, you must wait until it is complete.

Exiting the Configuration Utility

1. Press <Esc> when the **Management Menu** displays.
 2. Select **Yes** at the prompt.
 3. Reboot the system.
-

[Back to Contents Page](#)

Troubleshooting

Dell™ PowerEdge™ Expandable RAID Controller 4/SC and 4/DC User's Guide

- [General Problems](#)
- [BIOS Boot Error Messages](#)
- [Other Potential Problems](#)
- [Cache Migration](#)
- [SCSI Cable and Connector Problems](#)
- [Audible Warnings](#)

General Problems

[Table 6-1](#) describes general problems you might encounter, along with suggested solutions.

Table 6-1. General Problems

Problem	Suggested Solution
Some operating systems do not load in a system with a RAID controller.	<ol style="list-style-type: none"> 1 Check the system basic input/output system (BIOS) configuration for PCI interrupt assignments. Make sure a unique interrupt is assigned for the RAID controller. Initialize the logical drive before installing the operating system.
One of the hard drives in the array fails often.	<ol style="list-style-type: none"> 1 Check the SCSI cables. 1 Check the drive error counts. 1 Clear the data on the drive. 1 Rebuild the drive. 1 If the drive continues to fail, replace the drive with another drive of the same capacity. <p>If the drives are not the same size, the array uses the size of the smallest drive and the same amount of space on the other drives to construct the arrays. The larger hard drives are truncated.</p>
After pressing <Ctrl><M> during bootup and trying to make a new configuration, the system hangs when scanning devices.	<ol style="list-style-type: none"> 1 Check the drives IDs on each channel to make sure each device has a different ID. 1 Check to make sure an internal connection and external connection are not occupying the same channel. 1 Check the termination. The device at the end of the channel must be terminated. 1 Check to make sure that the RAID controller is seated properly in the slot. 1 Replace the drive cable.
Multiple drives connected to the RAID controller using the same power supply. There is a problem spinning the drives all at once.	<ol style="list-style-type: none"> 1 Set the drives to spin on command. This allows the RAID controller to spin two devices simultaneously.
Pressing <Ctrl><M> does not display a menu.	<ol style="list-style-type: none"> 1 These utilities require a color monitor.
At system power-up with the RAID controller installed, the BIOS banner display is garbled or does not appear at all.	<ol style="list-style-type: none"> 1 The RAID controller cache memory may be defective or missing.
Cannot flash or update the EEPROM.	<ol style="list-style-type: none"> 1 Contact Dell™ support for assistance. <p>⚠ CAUTION: Do not perform a firmware flash update while a check consistency or background initialization process is ongoing or failure could result.</p>
Firmware Initializing... appears and remains on the screen.	<ol style="list-style-type: none"> 1 Make sure that TERMPWR is being properly provided to each peripheral device populated channel. 1 Make sure that each end of the SCSI channel chain is properly terminated using the recommended terminator type for the peripheral device. The channel is automatically terminated at the RAID controller if only one cable is connected to a channel. 1 Make sure that the RAID controller is properly seated in the PCI slot.
The BIOS Configuration Utility does not detect a replaced physical drive in a RAID 1 array and offer the option to start a	Perform the following steps to solve this problem:

<p>rebuild.</p> <p>After the drive is replaced, the utility shows all drives online and all logical drives reporting optimal state. It does not allow rebuild because no failed drives are found.</p> <p>This occurs if you replace the drive with a drive that contains data. If the new drive is blank, this problem does not occur.</p> <p>If you exit from this screen and restart the server, the system will not find the operating system.</p>	<ol style="list-style-type: none"> 1 Access the BIOS Configuration Utility and select Objects--> Physical Drive to display the list of physical drives. 1 Use the arrow key to select the newly inserted drive, then press <Enter>. <p>The menu for that drive displays.</p> <ol style="list-style-type: none"> 1 Select Force Offline and press <Enter>. <p>This changes the physical drive from Online to Failed.</p> <ol style="list-style-type: none"> 1 Select Rebuild and press <Enter>. <p>After rebuilding is complete, the problem is resolved and the operating system will boot.</p>
---	---

BIOS Boot Error Messages

[Table 6-2](#) describes error messages about the BIOS that can display at bootup, the problems, and suggested solutions.

Table 6-2. BIOS Boot Error Messages

Message	Problem	Suggested Solution
Adapter BIOS Disabled. No Logical Drives Handled by BIOS	The BIOS is disabled. Sometimes the BIOS is disabled to prevent booting from the BIOS. This is the default when cluster mode is enabled.	<ol style="list-style-type: none"> 1 Enable the BIOS by pressing <Ctrl><M> at the boot prompt to run the BIOS Configuration Utility.
Host Adapter at Baseport xxxx Not Responding	The BIOS cannot communicate with the adapter firmware.	<ol style="list-style-type: none"> 1 Make sure the RAID controller is properly installed. 1 Check SCSI termination and cables.
No PERC 4 Adapter	The BIOS cannot communicate with the adapter firmware.	<ol style="list-style-type: none"> 1 Make sure the RAID controller is properly installed.
Run View/Add Configuration option of Configuration Utility. Press A Key to Run Configuration Utility Or <Alt><F10> to Continue.	The configuration data stored on the RAID controller does not match the configuration data stored on the drives.	<ol style="list-style-type: none"> 1 Press <Ctrl><M> to run the BIOS Configuration Utility. 1 Select Configure--> View/Add Configuration to examine both the configuration data in non-volatile random access memory (NVRAM) and the configuration data stored on the hard drives. 1 Resolve the problem by selecting one of the configurations. 1 If you press <Alt><F10> to continue, the configuration data on the NVRAM will be used to resolve the mismatch.
Unresolved configuration mismatch between disks and NVRAM on the adapter after creating a new configuration	Some legacy configurations in the drives cannot be cleared.	<ol style="list-style-type: none"> 1 Clear the configuration. 1 Clear the related drives and re-create the configuration.
1 Logical Drive Failed	A logical drive failed to sign on.	<ol style="list-style-type: none"> 1 Make sure all physical drives are properly connected and are powered on. 1 Run the BIOS Configuration Utility to find out whether any physical drives are not responding. 1 Reconnect, replace, or rebuild any drive that is not responding.
X Logical Drives Degraded	X number of logical drives signed on in a degraded state.	<ol style="list-style-type: none"> 1 Make sure all physical drives are properly connected and are powered on. 1 Run the BIOS Configuration Utility to find whether any physical drives are not responding. 1 Reconnect, replace, or rebuild a drive that is not responding.
1 Logical Drive Degraded	A logical drive signed on in a degraded state.	<ol style="list-style-type: none"> 1 Make sure all physical drives are properly connected and are powered on. 1 Run a RAID utility to find out if any physical drives are not responding.

		<ol style="list-style-type: none"> 1 Reconnect, replace, or rebuild any drive that is not responding.
Insufficient memory to run BIOS Press any key to continue...	Not enough memory to run the BIOS	<ol style="list-style-type: none"> 1 Make sure the cache memory has been properly installed.
Insufficient Memory	Not enough memory on the adapter to support the current configuration.	<ol style="list-style-type: none"> 1 Make sure the cache memory has been properly installed.
The following SCSI IDs are not responding: Channel x:a,b,c	The physical drives with SCSI IDs a, b, and c are not responding on SCSI channel x.	<ol style="list-style-type: none"> 1 Make sure the physical drives are properly connected and are powered on.
Following SCSI disk not found and no empty slot available for mapping it	The physical disk roaming feature did not find the physical disk with the displayed SCSI ID. No slot is available to map the physical drive and the RAID controller cannot resolve the physical drives into the current configuration.	<ol style="list-style-type: none"> 1 Reconfigure the array.
Following SCSI IDs have the same data y, z Channel x: a, b, c	The physical drive roaming feature found the same data on two or more physical drives on channel x with SCSI IDs a, b, and c. The RAID controller cannot determine the drive that has the duplicate information.	<ol style="list-style-type: none"> 1 Remove the drive or drives that should not be used.
Unresolved configuration mismatch between disks and NVRAM on the adapter	The RAID controller is unable to determine the proper configuration after reading both NVRAM and Configuration on Disk	<ol style="list-style-type: none"> 1 Press <Ctrl><M> to run the BIOS Configuration Utility. 1 Select Configure—> New Configuration to create a new configuration. <p>Note that this will delete any configuration that existed.</p>

Other Potential Problems

[Table 6-3](#) describes other problems that can occur.

Table 6-3. Other Potential Problems

Topic	Information
Physical drive errors	<p>To display the BIOS Configuration Utility Media Error and Other Error options, press <F2> after selecting a physical drive under the Objects—> Physical Drive menu.</p> <p>A Media Error is an error that occurs while transferring data.</p> <p>An Other Error is an error that occurs at the hardware level, such as a device failure, poor cabling, bad termination, or signal loss.</p>
RAID controller power requirements	The maximum power requirements are 15 watts at 5-V and 3 Amps.
Windows NT does not detect the RAID controller.	Refer to the <i>CERC and PERC RAID Controllers Operating System Driver Installation Guide</i> for the section about Windows NT driver installation.

Cache Migration

To move cache memory from one controller to another, first determine whether the cache memory contains data, then transfer it to the other controller. The cache memory with a transportable battery backup unit (TBBU) contains an LED that lights up if data exists on the cache memory.

If the cache memory contains data, perform the following steps before you move the cache from one controller to another:

- 1 Make sure the NVRAM configuration on the new controller is cleared.

See [RAID Controller Features](#) for information about the jumper to set to clear NVRAM.

- 1 Make sure that the configuration data on the disks is intact.
- 1 Transfer the cache to the new controller and connect the drives in the same order as they were connected on the previous adapter.

This ensures that the configuration data on the cache matches the configuration data on they physical disks. This is important for successful cache migration.

- 1 Power on the system.

SCSI Cable and Connector Problems

If you are having problems with your SCSI cables or connectors, first check the cable connections. If still having a problem, visit the Dell's web site at www.dell.com for information about qualified small computer system interface (SCSI) cables and connectors or contact your Dell representative for information.

Audible Warnings

The RAID controller has a speaker that generates warnings to indicate events and errors. [Table 6-4](#) describes the warnings.

Table 6-4. Audible Warnings

Tone Pattern	Meaning	Examples
Three seconds on and one second off	A logical drive is offline.	One or more drives in a RAID 0 configuration failed. Two or more drives in a RAID 1 or 5 configuration failed.
One second on and one second off	A logical drive is running in degraded mode.	One drive in a RAID 5 configuration failed.
One second on and three seconds off	An automatically initiated rebuild has been completed.	While you were away from the system, a hard drive in a RAID 1 or 5 configuration failed and was rebuilt.

[Back to Contents Page](#)

[Back to Contents Page](#)

Appendix A: Regulatory Notice

Dell™ PowerEdge™ Expandable RAID Controller 4/SC and 4/DC User's Guide

- [FCC Notices \(U.S. Only\)](#)
 - [A Notice About Shielded Cables:](#)
 - [Class B](#)
 - [Canadian Compliance \(Industry Canada\)](#)
 - [MIC](#)
 - [VCCI Class B Statement](#)
-

FCC Notices (U.S. Only)

Most Dell systems are classified by the Federal Communications Commission (FCC) as Class B digital devices. However, the inclusion of certain options changes the rating of some configurations to Class A. To determine which classification applies to your system, examine all FCC registration labels located on the back panel of your system, on card-mounting brackets, and on the controllers -themselves. If any one of the labels carries a Class A rating, your entire system is considered to be a Class A digital device. If all labels carry either the Class B rating or the FCC logo (FCC), your system is considered to be a Class B digital device.

Once you have determined your system's FCC classification, read the appropriate FCC notice. Note that FCC regulations provide that changes or modifications not expressly approved by Dell Inc. could void your authority to operate this equipment.

A Notice About Shielded Cables:

Use only shielded cables for connecting peripherals to any Dell device to reduce the possibility of interference with radio and television reception. Using shielded cables ensures that you maintain the appropriate FCC radio frequency emissions compliance (for a Class A device) or FCC certification (for a Class B device) of this product. For parallel printers, a cable is available from Dell Inc.

Class B

This equipment generates, uses, and can radiate radio frequency energy and, if not installed and used in accordance with the manufacturer's instruction manual, may cause interference with radio and television reception. This equipment has been tested and found to comply with the limits for a Class B digital device pursuant to Part 15 of the FCC Rules. These limits are designed to provide reasonable protection against harmful interference in a residential installation.

However, there is no guarantee that interference will not occur in a particular installation. If this equipment does cause harmful interference with radio or television reception, which can be determined by turning the equipment off and on, you are encouraged to try to correct the interference by one or more of the following measures:

- 1 Reorient the receiving antenna.
- 1 Relocate the system with respect to the receiver.
- 1 Move the system away from the receiver.
- 1 Plug the system into a different outlet so that the system and the receiver are on different branch circuits.

If necessary, consult a representative of Dell Inc. or an experienced radio/television technician for additional suggestions. You may find the following booklet helpful: FCC Interference Handbook, 1986, available from the U.S. Government Printing Office, Washington, DC 20402, Stock No. 004-000-00450-7. This device complies with Part 15 of the FCC Rules. Operation is subject to the following two conditions:

- 1 This device may not cause harmful interference.
- 1 This device must accept any interference received, including interference that may cause undesired operation.

The following information is provided on the device or devices covered in this document in compliance with FCC regulations:

1 Product name: Dell PowerEdge Expandable RAID Controller 4 Controller
1 Company name:
Dell Inc.
Regulatory Department
One Dell Way
Round Rock, Texas 78682 USA
512-338-4400

Canadian Compliance (Industry Canada)

Canadian Regulatory Information (Canada Only)

This digital apparatus does not exceed the Class B limits for radio noise emissions from digital apparatus set out in the Radio Interference Regulations of the Canadian Department of Communications. Note that the Canadian Department of Communications (DOC) regulations provide, that changes or modifications not expressly approved by Intel could void your authority to operate the equipment. This Class B digital apparatus meets all the requirements of the Canadian Interference -Causing Equipment Regulations.

Cet appareil numerique de la classe B respecte toutes les exigences du Reglement sur la material brouilleur du Canada.

MIC

B Class Device

기종별	사용자 안내문
B급 기기 (가정용 정보통신기기)	이 기기는 가정용으로 전자파적합등록을 한 기기로서 주거지역에서는 물론 모든 지역에서 사용할 수 있습니다.

Please note that this device has been approved for non-business purposes and may be used in any environment, including residential areas.



VCCI Class B Statement

この装置は、情報処理装置等電波障害自主規制協議会（VCCI）の基準に基づくクラスB情報技術装置です。この装置は、家庭環境で使用することを目的としていますが、この装置がラジオやテレビジョン受信機に近接して使用されると、受信障害を引き起こすことがあります。
取扱説明書に従って正しい取り扱いをして下さい。

[Back to Contents Page](#)

[Back to Contents Page](#)

Glossary

Dell™ PowerEdge™ Expandable RAID Controller 4/SC, 4/DC, and 4e/DC User's Guide

[A](#) • [C](#) • [D](#) • [E](#) • [G](#) • [H](#) • [I](#) • [L](#) • [M](#) • [O](#) • [P](#) • [R](#) • [S](#)

Array

A grouping of hard drives that combines the storage space on the hard drives into a single segment of contiguous storage space. The RAID controller can group hard drives on one or more channels into an array. A hot spare drive does not participate in an array.

Array Spanning

Array spanning by a logical drive combines storage space in two arrays of hard drives into a single, contiguous storage space in a logical drive. The logical drive can span consecutively numbered arrays, each having the same number of hard drives. Array spanning promotes RAID level 1 to RAID level 10. See also [Disk Spanning](#), and [Spanning](#).

Asynchronous Operations

Operations that are not related to each other in time and can overlap. The concept of asynchronous I/O operations is central to independent access arrays in throughput-intensive applications.

Cache I/O

A small amount of fast memory that holds recently accessed data. Caching speeds subsequent access to the same data. It is most often applied to processor-memory access, but can also be used to store a copy of data accessible over a network. When data is read from or written to main memory, a copy is also saved in cache memory with the associated main memory address. The cache memory software monitors the addresses of subsequent reads to see if the required data is already stored in cache memory. If it is already in cache memory (a cache hit), it is read from cache memory immediately and the main memory read is aborted (or not started.) If the data is not cached (a cache miss), it is fetched from main memory and saved in cache memory.

Channel

An electrical path for the transfer of data and control information between a disk and a disk controller.

Clearing

In the BIOS Configuration Utility, the option used to delete information from physical drives.

Consistency Check

An examination of the data in the hard drives in a logical drive to ensure that the data is redundant.

Cold Swap

A cold swap requires that you power down the system before replacing a defective hard drive in a disk subsystem.

Data Transfer Capacity

The amount of data per unit time moved through a channel. For disk I/O, bandwidth is expressed in megabytes per second (MB/sec).

Degraded Drive

A logical drive that has become non-functional or has a hard drive that is non-functional.

Disk

A non-volatile, randomly addressable, rewritable mass storage device, including both rotating magnetic and optical disks and solid-state disks, or non-volatile electronic storage elements. It does not include specialized devices such as write-once-read-many (WORM) optical disks, nor does it include so-called RAM disks implemented using software to control a dedicated portion of a host system's volatile random access memory.

Disk Array

A collection of disks from one or more disk subsystems combined using a configuration utility. The utility controls the disks and presents them to the array operating environment as one or more logical drives.

Disk Mirroring

Disk mirroring is the process of duplicating the data onto another drive (RAID 1) or set of drives (in RAID 10), so that if a drive fails, the other drive has the same data and no data is lost.

Disk Spanning

Disk spanning allows multiple logical drives to function as one big logical drive. Spanning overcomes lack of disk space and simplifies storage management by combining existing resources or adding relatively inexpensive resources. See also [Array Spanning](#) and [Spanning](#).

Disk Striping

A type of disk array mapping. Consecutive stripes of data are mapped round-robin to consecutive array members. A striped array (RAID level 0) provides high I/O performance at low cost, but provides no data redundancy.

Disk Subsystem

A collection of disks and the hardware that connects them to one or more host systems. The hardware can include an intelligent controller, or the disks can attach directly to a host system.

Double Buffering

A technique that achieves maximum data transfer bandwidth by constantly keeping two I/O requests for adjacent data outstanding. A software component begins a double-buffered I/O stream by issuing two requests in rapid sequence. Thereafter, each time an I/O request completes, another is immediately issued. If the disk subsystem is capable of processing requests fast enough, double buffering allows data to be transferred at the full-volume transfer rate.

Failed Drive

A drive that has ceased to function or consistently functions improperly.

Firmware

Software stored in read-only memory (ROM) or Programmable ROM (PROM). Firmware is often responsible for the startup routines and low-level I/O processes of a system when it is first turned on.

FlexRAID Power Fail Option

The FlexRAID Power Fail option allows drive reconstruction, rebuild, and check consistency to continue when the system restarts because of a power failure, reset, or hard boot. This is the advantage of the FlexRAID option. The disadvantage is, once the reconstruction is active, the performance is slower because an additional activity is running.

Formatting

The process of writing zeros to all data fields in a physical drive (hard drive) to map out unreadable or bad sectors. Because most hard drives are factory formatted, formatting is usually only done if a hard disk generates many media errors.

GB

(gigabyte) 1,073,741,824 bytes. It is the same as 1,024 MB (megabytes).

Host System

Any system to which disks are directly attached. Mainframes, servers, workstations, and personal systems can all be considered host systems.

Hot Spare

A stand-by drive ready for use if another drive fails. It does not contain any user data. Up to eight hard drives can be assigned as hot spares for an adapter.

Hot Swap

The substitution of a replacement unit in a disk subsystem for a defective one, where the substitution can be performed while the subsystem is running (performing its normal functions). Hot swaps are manual. The backplane and enclosure must support hot swap in order for the functionality to work.

IDE

(Integrated Device Electronics) Also known as ATA (Advanced Technology Attachment), this is a type of interface for the hard drive, in which the controller electronics are integrated onto the drive itself. With IDE, a separate adapter card is no longer needed; this reduces interface costs and makes it easier to implement firmware.

I/O Driver

A host system software component (usually part of the operating system) that controls the operation of peripheral controllers or adapters attached to the host system. I/O drivers communicate between applications and I/O devices, and in some cases participates in data transfer.

Initialization

The process of writing zeros to the data fields of a logical drive and generating the corresponding parity to bring the logical drive to a Ready state. Initializing erases previous data and generates parity so that the logical drive will pass a consistency check. Arrays can work without initializing, but they can fail a consistency check because the parity fields have not been generated.

Logical Disk

A set of contiguous chunks on a physical disk. Logical disks are used in array implementations as constituents of logical volumes or partitions. Logical disks are normally transparent to the host environment, except when the array containing them is being configured.

Logical Drive

A virtual drive within an array that can consist of more than one physical drive. Logical drives divide the storage space of an array of hard drives or a spanned group of arrays of drives. The storage space in a logical drive is spread across all the physical drives in the array or spanned arrays.

Mapping

The conversion between multiple data addressing schemes, especially conversions between member disk block addresses and block addresses of the virtual disks presented to the operating environment.

MB

(Megabyte) An abbreviation for 1,048,576 (102) bytes. It is the same as 1,000 KB (kilobytes).

Multi-threaded

Having multiple concurrent or pseudo-concurrent execution sequences. Used to describe processes in systems. Multi-threaded processes allow throughput-intensive applications to efficiently use a disk array to increase I/O performance.

Operating Environment

The operating environment includes the host system where the group of hard drives is attached, any I/O buses and controllers, the host operating system, and any additional software required to operate the array. For host-based arrays, the operating environment includes I/O driver software for the member disks.

Parity

Parity is an extra bit added to a byte or word to reveal errors in storage (in RAM or disk) or transmission. Parity is used to generate a set of redundancy data from two or more parent data sets. The redundancy data can be used to reconstruct one of the parent data sets; however, parity data does not fully duplicate the parent data sets. In RAID, this method is applied to entire drives or stripes across all hard drives in an array. Parity consists of dedicated parity, in which the parity of the data on two or more drives is stored on an additional drive, and distributed parity, in which the parity data are distributed among all the drives in the system. If a single drive fails, it can be rebuilt from the parity of the respective data on the remaining drives.

Partition

A separate logical area of memory or a storage device that acts as though it were a physically separate area.

Physical Disk

A hard drive that stores data. A hard drive consists of one or more rigid magnetic discs rotating about a central axle with associated read/write heads and electronics.

Physical Disk Roaming

The ability of some adapters to detect when hard drives have been moved to a different slots in the system, for example, after a hot swap.

RAID

(Redundant Array of Independent Disks) An array of multiple independent hard disk drives that yields better performance than a Single Large Expensive Disk (SLED). A RAID disk subsystem improves I/O performance on a server using only a single drive. The RAID array appears to the host server as a single storage unit. I/O is expedited because several disks can be accessed simultaneously.

RAID Levels

A style of redundancy applied to a logical drive. It can increase the performance of the logical drive and can decrease usable capacity. Each logical drive must have a RAID level assigned to it. The RAID level drive requirements are: RAID 0 requires at least one physical drive, RAID 1 requires two physical drives, RAID 5 requires at least three physical drives and RAID 10 requires at least four physical drives. RAID 10 results when a RAID 1 logical drive spans arrays.

RAID Migration

RAID migration is used to move between optimal RAID levels or to change from a degraded redundant logical drive to an optimal RAID 0. In Novell, the utility used for RAID migration is MEGAMGR.

Read-Ahead

A memory caching capability in some adapters that allows them to read sequentially ahead of requested data and store the additional data in cache memory, anticipating that the additional data will be needed soon. Read-Ahead supplies sequential data faster, but is not as effective when accessing random data.

Ready State

A condition in which a workable hard drive is neither online nor a hot spare and is available to add to an array or to designate as a hot spare.

Rebuild

The regeneration of all data from a failed disk in a RAID level 1, 5, 10, or 5 array to a replacement disk. A disk rebuild normally occurs without interruption of application access to data stored on the array virtual disk.

Rebuild Rate

The percentage of CPU resources devoted to rebuilding.

Reconstruct

The act of remaking a logical drive after changing RAID levels or adding a physical drive to an existing array.

Redundancy

The provision of multiple interchangeable components to perform a single function to cope with failures or errors. Redundancy normally applies to hardware; a common form of hardware redundancy is disk mirroring.

Replacement Disk

A disk available to replace a failed member disk in a RAID array.

Replacement Unit

A component or collection of components in a disk subsystem that are always replaced as a unit when any part of the collection fails. Typical replacement units in a disk subsystem includes disks, controller logic boards, power supplies, and cables. Also called a hot spare.

SCSI

(small computer system interface) A processor-independent standard for system-level interfacing between a system and intelligent devices, including hard disks, diskettes, CD drives, printers, scanners, etc. SCSI can connect up to seven devices to a single adapter (or host adapter) on the system's bus. SCSI transfers eight or 16 bits in parallel and can operate in either asynchronous or synchronous modes. The synchronous transfer rate is up to 320 MB/sec. SCSI connections normally use single-ended drivers, as opposed to differential drivers.

The original standard is now called SCSI-1 to distinguish it from SCSI-2 and SCSI-3, which include specifications of Wide SCSI (a 16-bit bus) and Fast SCSI (10 MB/sec transfer.) Ultra 160M SCSI is a subset of Ultra3 SCSI and allows a maximum throughput of 160 MB/sec, which is more than twice as fast as Wide Ultra2 SCSI. Ultra320 SCSI allows a maximum throughput of 320 MB/sec.

Spanning

Array spanning by a logical drive combines storage space in two arrays of hard drives into a single, contiguous storage space in a logical drive. Logical drives can span consecutively numbered arrays that each consist of the same number of hard drives. Array spanning promotes RAID level 1 to RAID levels 10. See also [Array Spanning](#), and [Disk Spanning](#).

Spare

A hard drive available to back up the data of other drives.

Stripe Size

The amount of data contiguously written to each disk. You can specify stripe sizes of 4 KB, 8 KB, 16 KB, 32 KB, 64 KB, and 128 KB for each logical drive. For best performance, choose a stripe size equal to or smaller than the block size used by the host system.

Stripe Width

The number of hard drives across which the data are striped.

Striping

Segmentation of logically sequential data, such as a single file, so that segments can be written to multiple physical devices in a round-robin fashion. This technique is useful if the processor can read or write data faster than a single disk can supply or accept it. While data is being transferred from the first disk, the second disk can locate the next segment. Data striping is used in some modern databases and in certain RAID devices.

[Back to Contents Page](#)